

Lecture 3: Two-terminal devices

Fermi levels

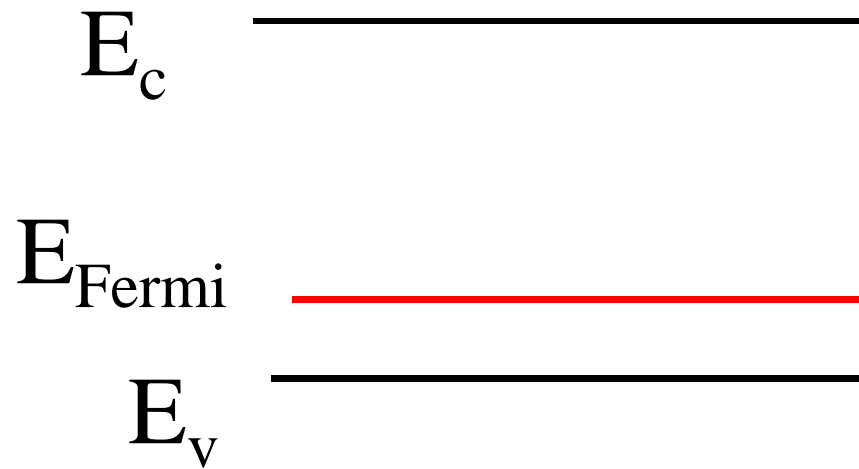

p-type

Fermi levels

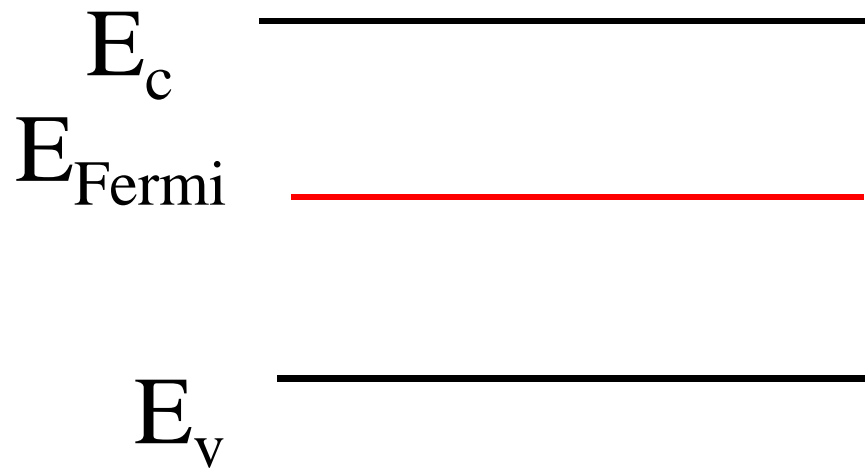

n-type

Fermi levels

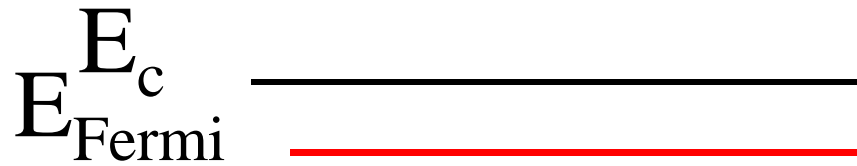

n-type

Degenerate doping

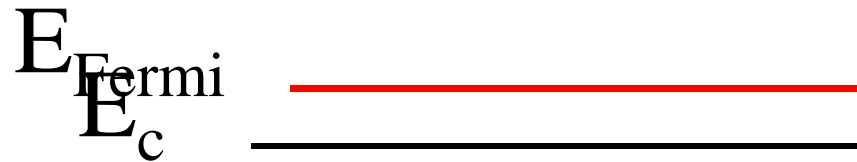

n-type

Invariance of Fermi level

- Fermi level must be constant if system is in equilibrium (no external voltage or force)
- Discuss on board

Junction types

- Homojunction
- Heterojunction

p-n junction

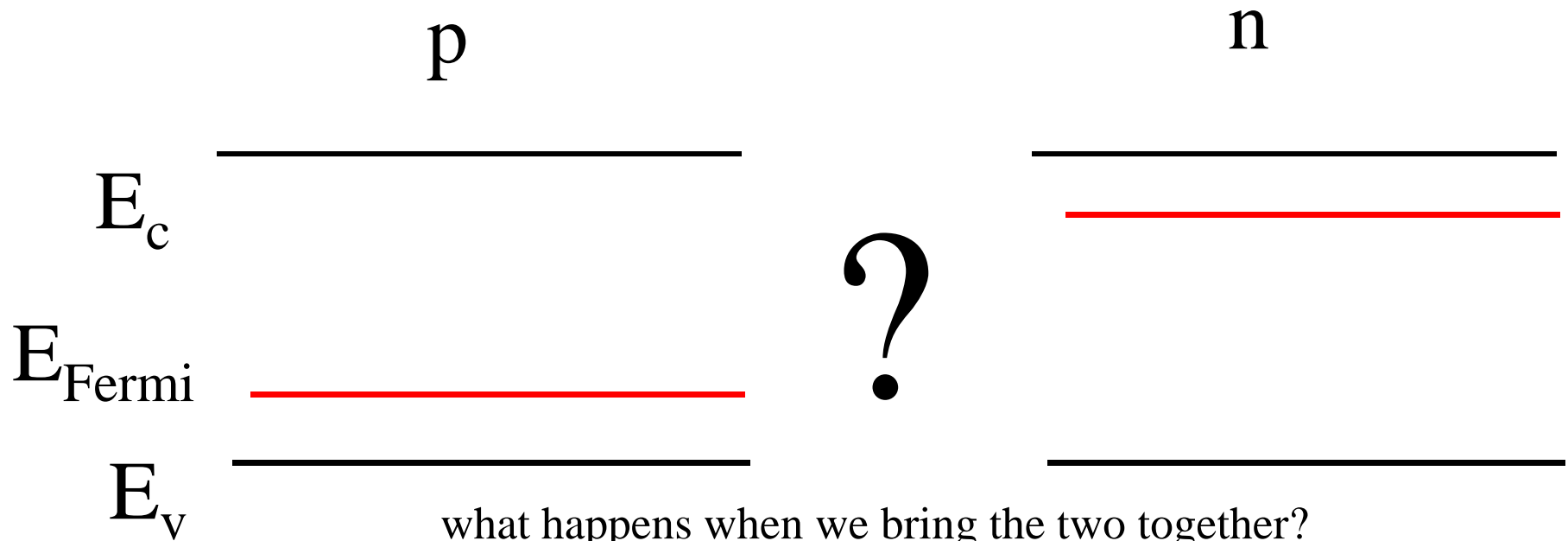

what happens when we bring the two together?
Electrons move from n to p
Holes move from p to n

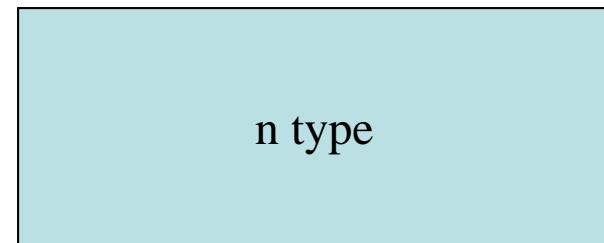
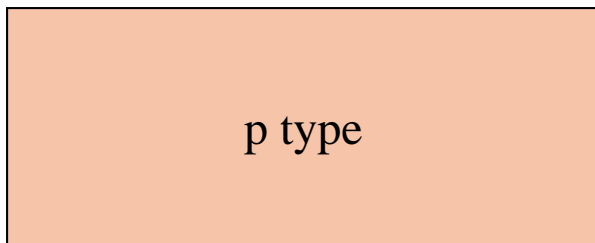

p-n junction

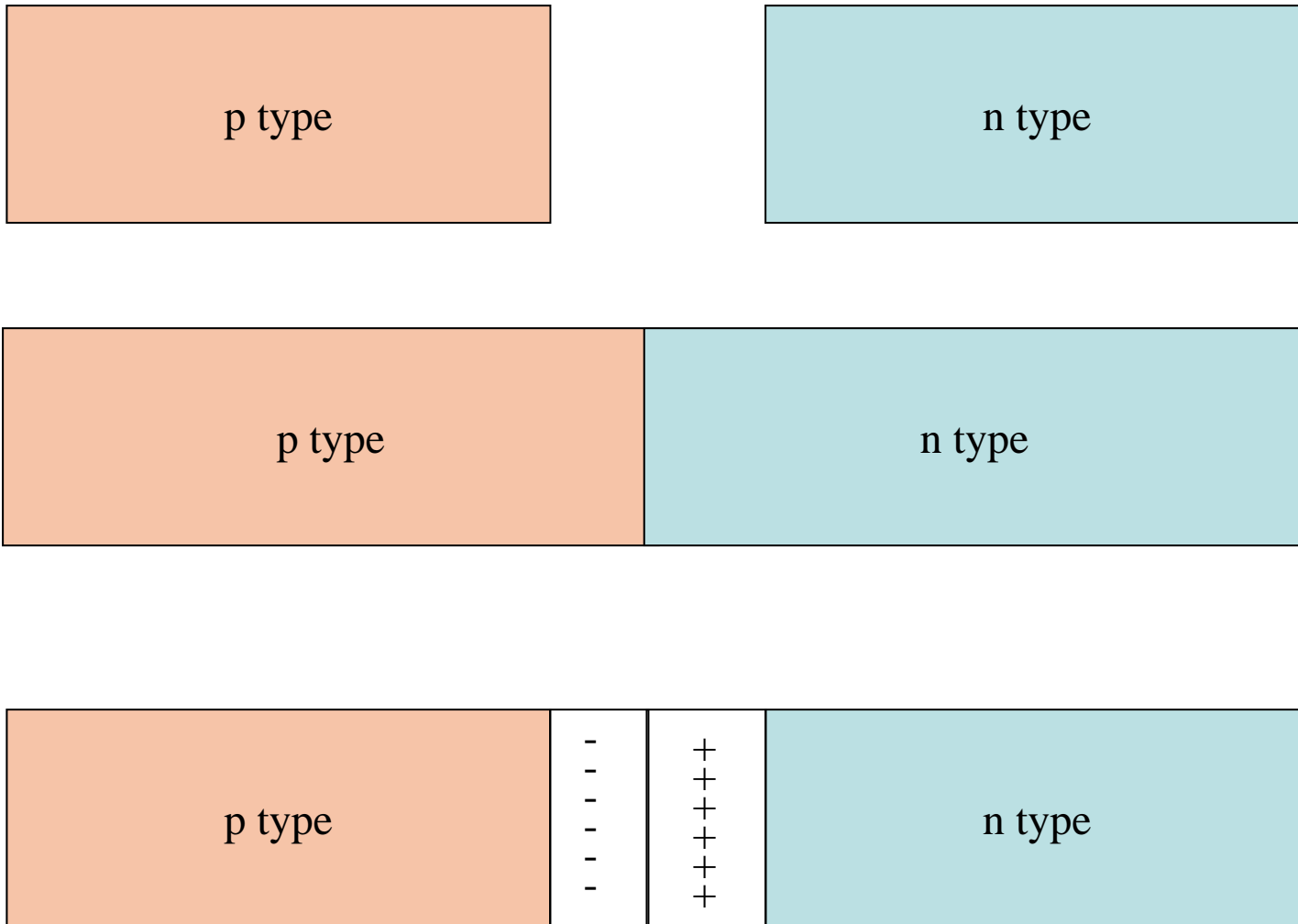

p-n junction

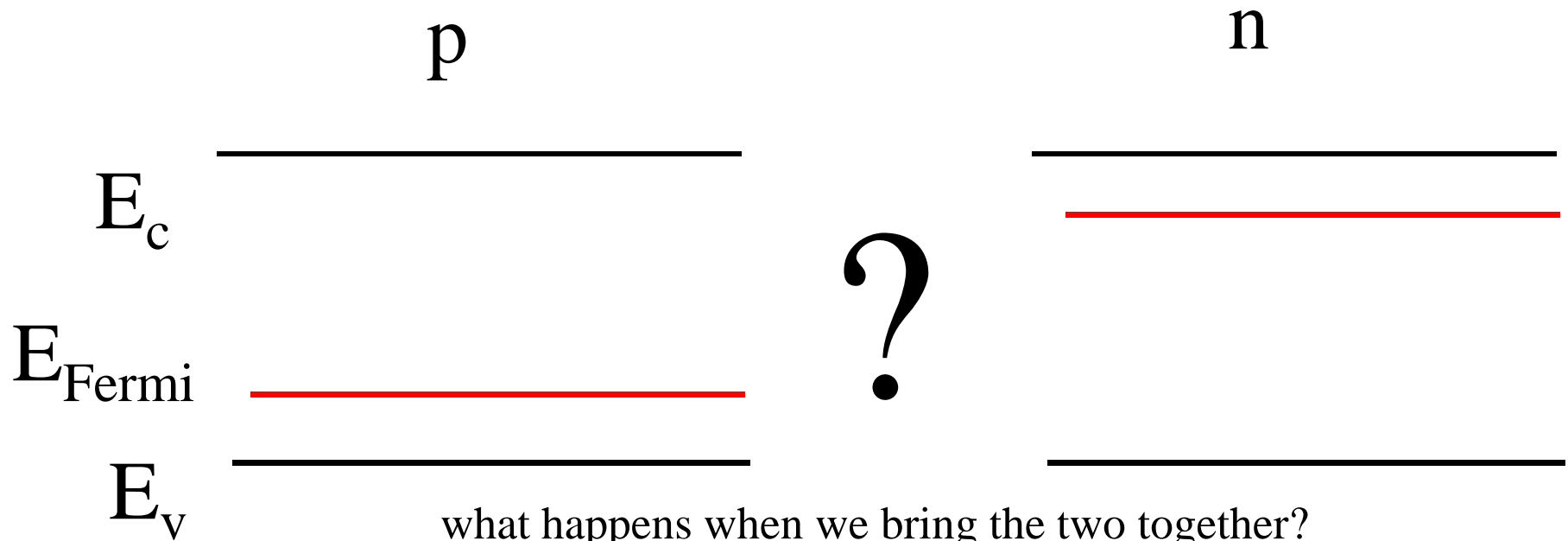

what happens when we bring the two together?
Electrons move from n to p
Holes move from p to n

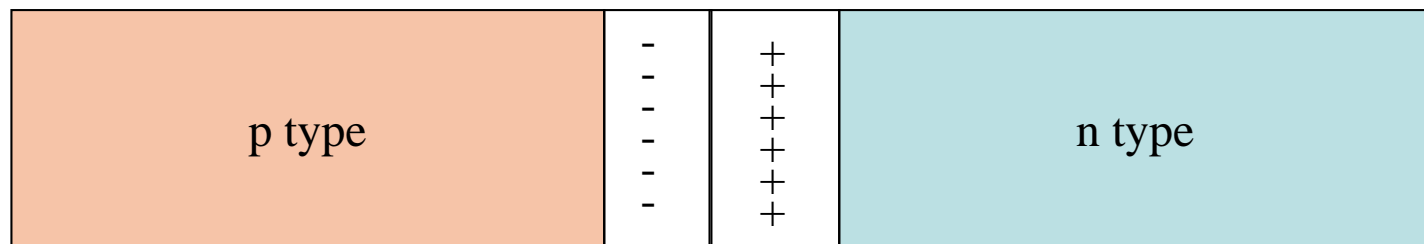

How to deal with?

- Away from junction, same as bulk
- In “depletion region” or “space charge region” no carriers
- But, there is an electric field which causes potential energy difference
- “Band bending” method: shift all levels of p side relative to n side
- Rule: align Fermi levels

p n diode

p type:

n type:

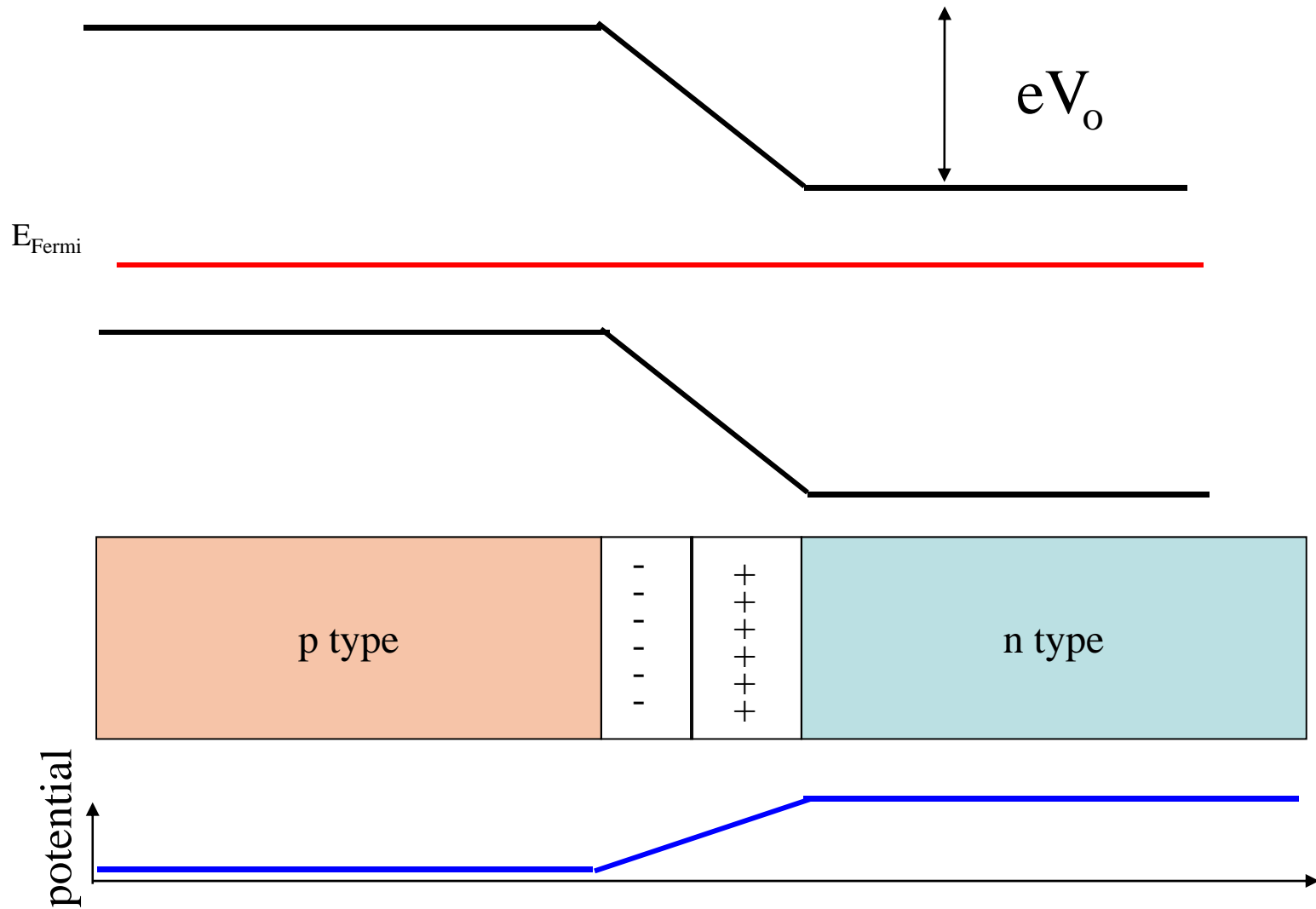

p n diode

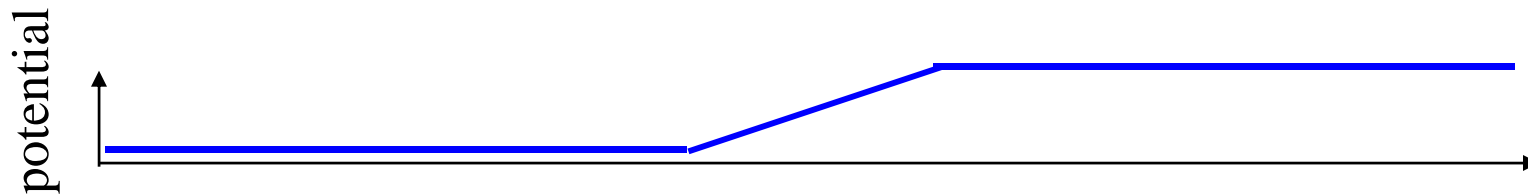
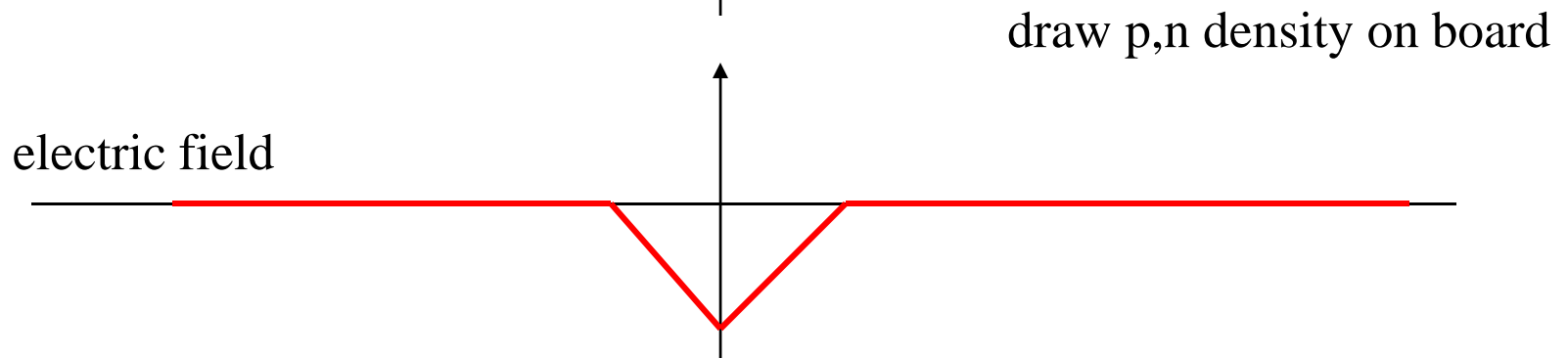
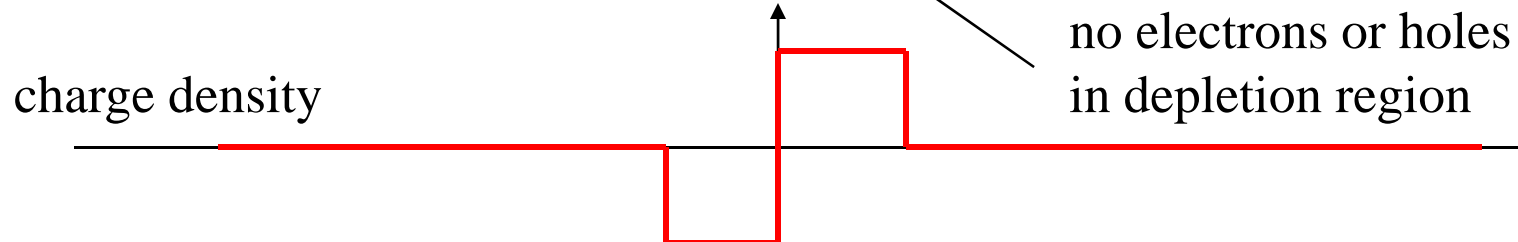
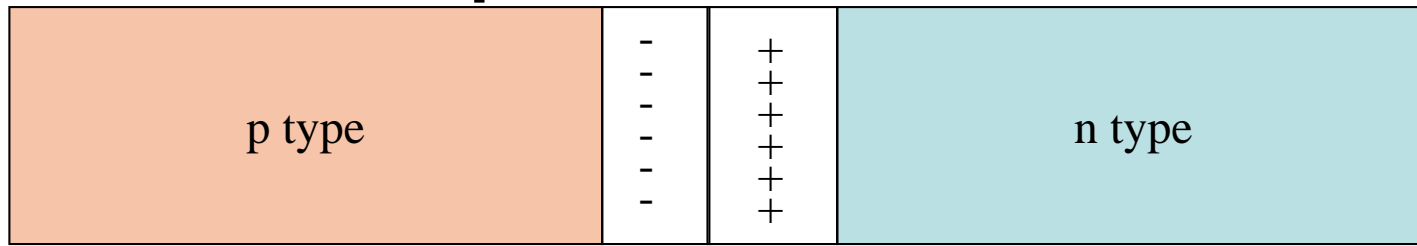

Poisson equation

Actually first of Maxwell's four equations:

$$\vec{\nabla} \cdot \vec{E} = -\frac{\rho}{\epsilon}$$

In the x-direction only:

$$\frac{dE}{dx} = \frac{q}{\epsilon_p} \left(p - n + N_d^+ - N_a^- \right)$$

Charge density

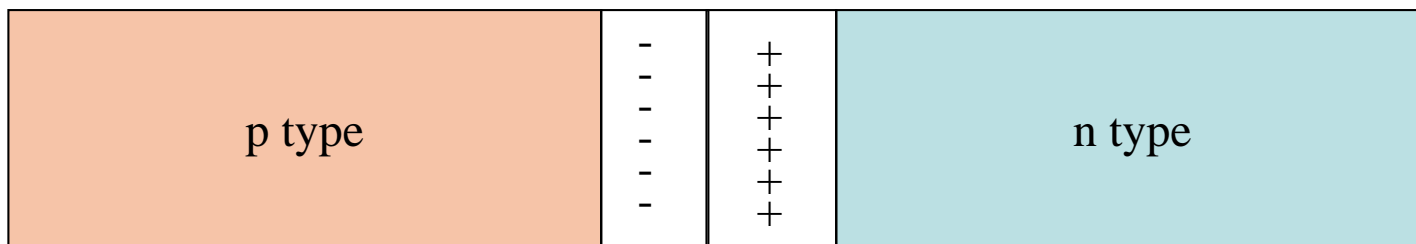
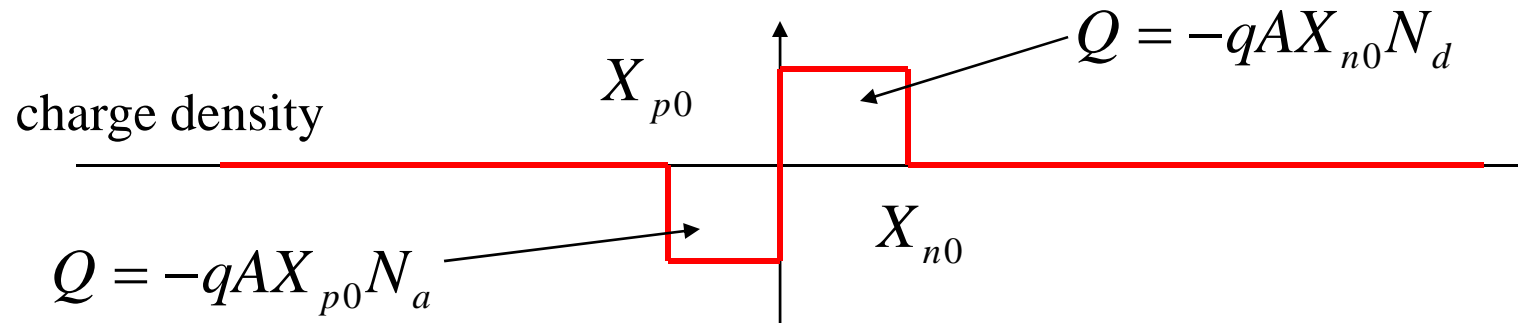

Electric field

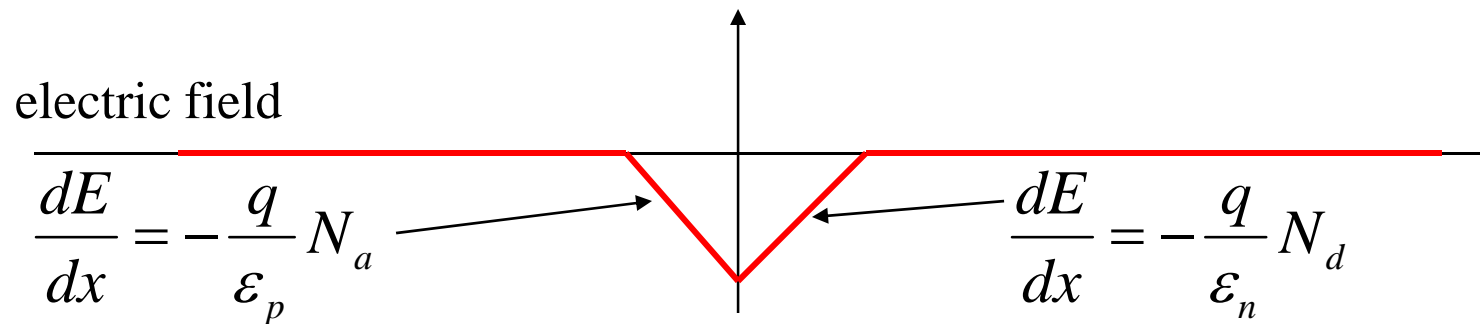
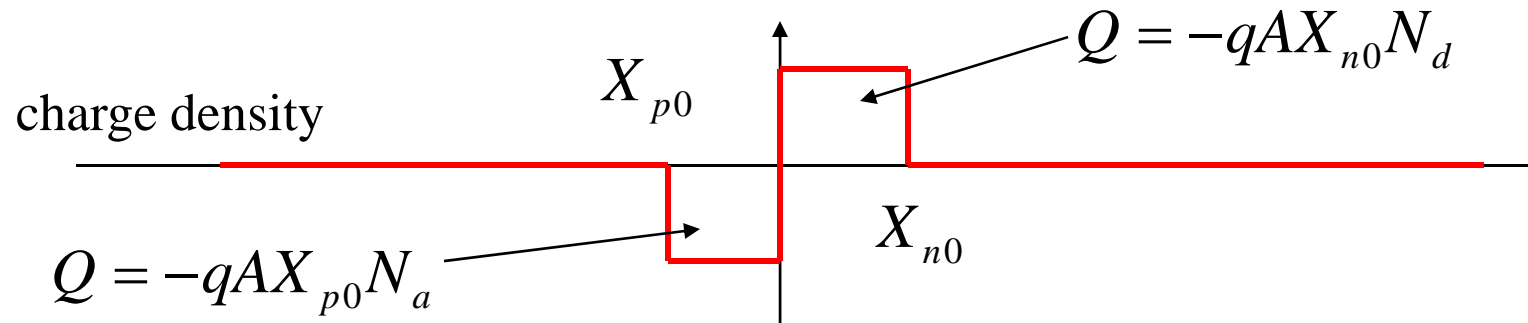

$$E(x) = -\frac{q}{\epsilon_p} N_a (x + X_{p0})$$

$$E(x) = -\frac{q}{\epsilon_p} N_d (X_{n0} - x)$$

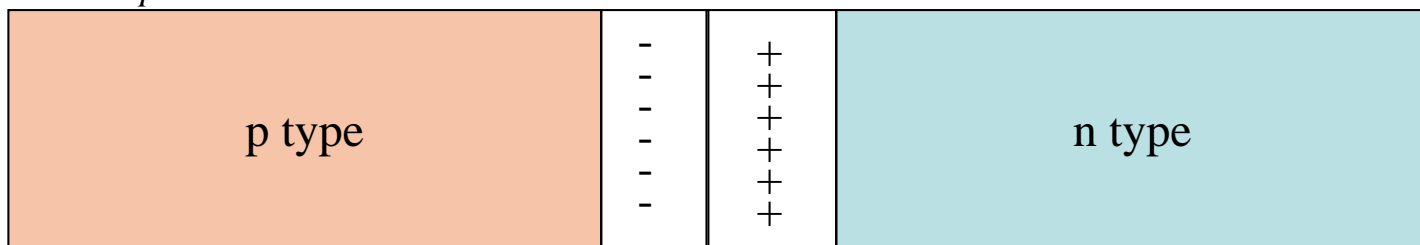

Electric potential

electric field

$$\frac{dE}{dx} = -\frac{q}{\epsilon_p} N_a$$

$$\frac{dE}{dx} = -\frac{q}{\epsilon_n} N_d$$

$$E(x) = -\frac{q}{\epsilon_p} N_a (x + X_{p0})$$

$$E(x) = -\frac{q}{\epsilon_p} N_d (X_{n0} - x)$$

$$V(x) = -\int E(x) dx = \frac{q}{\epsilon_p} N_a \left(\frac{x^2}{2} + X_{p0} x \right) + C$$

Define zero of V(x) at p side

$$V(x) = \frac{q}{\epsilon_p} N_a \left(\frac{x^2}{2} + X_{p0} x + \frac{X_{p0}^2}{2} \right)$$

$$V(x) = \frac{q}{\epsilon_n} N_d \left(X_{n0} x - \frac{x^2}{2} \right) + \phi_{p0}$$

$$V(0) = \frac{q}{\epsilon_p} N_a \frac{X_{p0}^2}{2} \equiv \phi_{p0}$$

$$\phi_{n0} \equiv V(x) = \frac{q}{2\epsilon_n} N_d X_{n0}^2$$

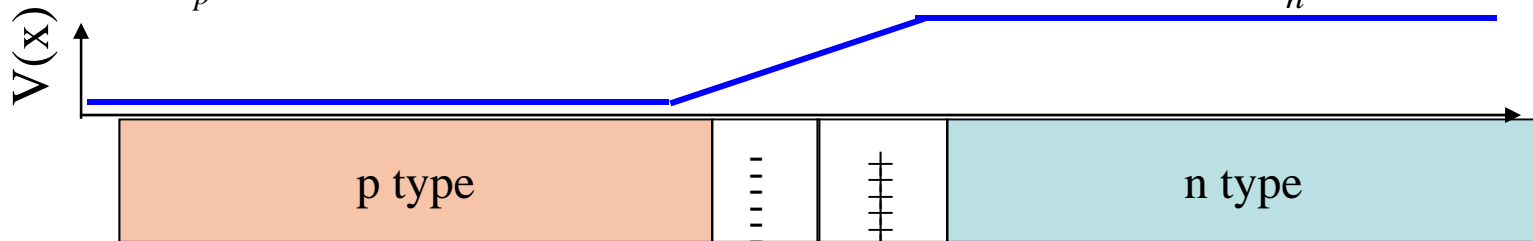

built in potential

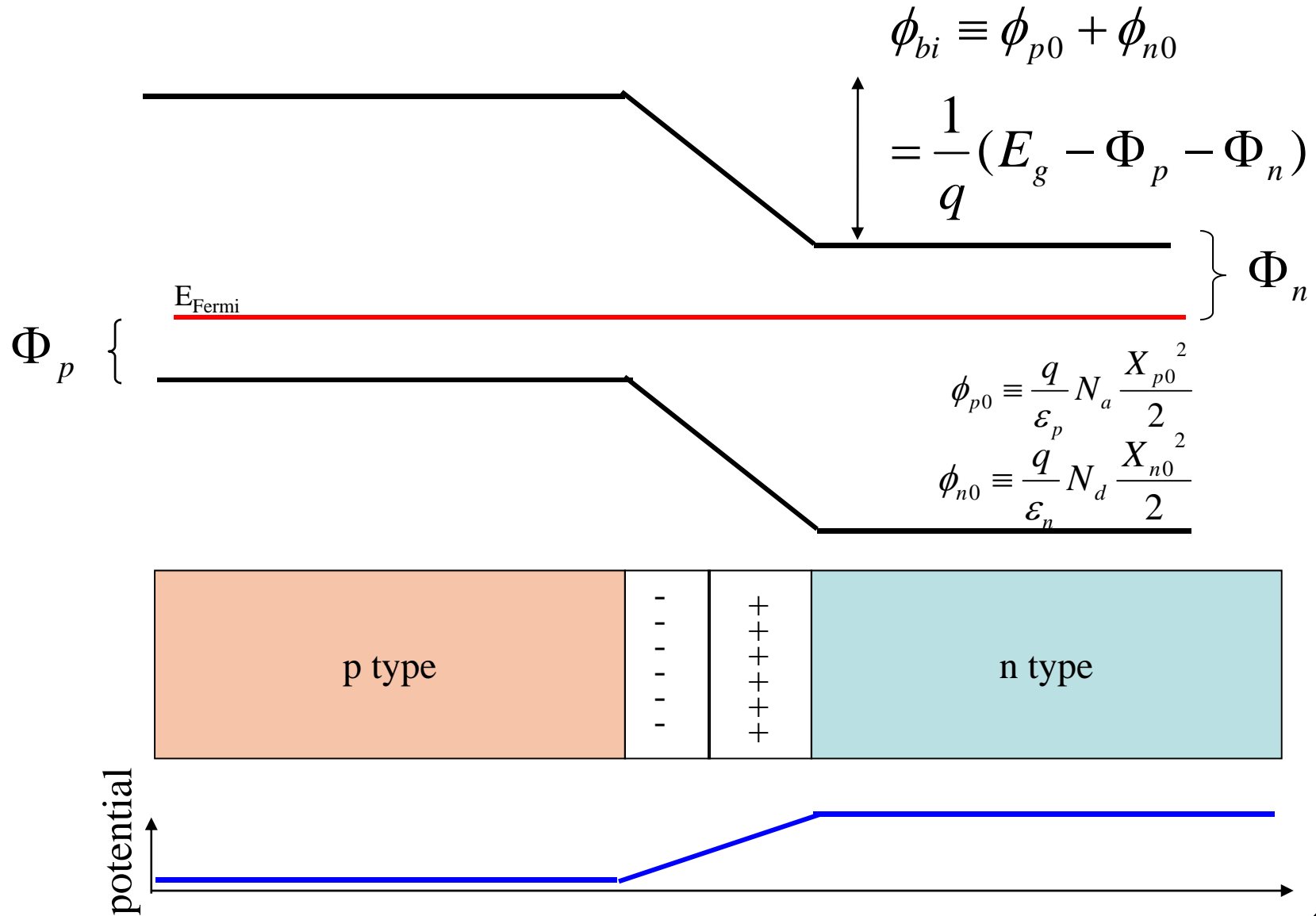

Depletion region width

$$\phi_{bi} \equiv \phi_{p0} + \phi_{n0} = \frac{1}{q} (E_g - \Phi_p - \Phi_n)$$

$$\phi_{p0} \equiv \frac{q}{\varepsilon_p} N_a \frac{X_{p0}^2}{2} \quad \phi_{n0} \equiv \frac{q}{\varepsilon_n} N_d \frac{X_{n0}^2}{2}$$

$$Q_p = -qAX_{p0}N_a \quad Q_n = -qAX_{n0}N_d$$

$$Q_p = Q_n \Rightarrow qAX_{p0}N_a = -qAX_{n0}N_d$$

\Rightarrow

$$W = \sqrt{\frac{2\varepsilon\phi_{bi}}{q} \left(\frac{1}{N_d} + \frac{1}{N_a} \right)}$$

Numerical example

$$N_d = 10^{16} \text{ cm}^{-3}$$

$$N_a = 10^{18} \text{ cm}^{-3}$$

$$\Rightarrow W = X_{p0} + X_{n0} = 0.33 \mu\text{m}$$

$$\Rightarrow X_{p0} = 8.3 \text{ \AA}$$

Forward bias

p type:

n type:

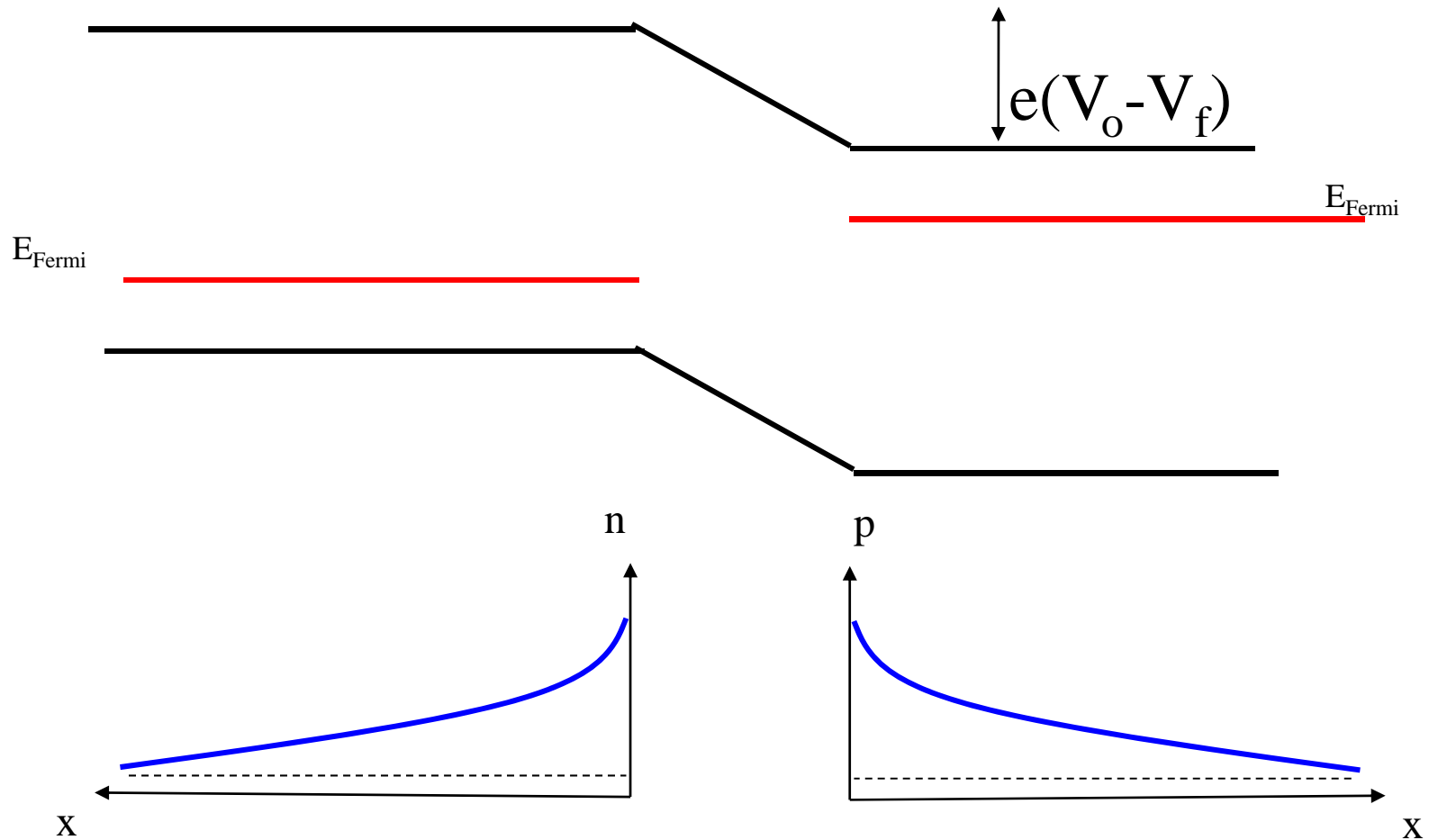

Discuss current vs. x

$$j_n = dn/dx$$

$$j = j_n + j_p$$

Capacitance

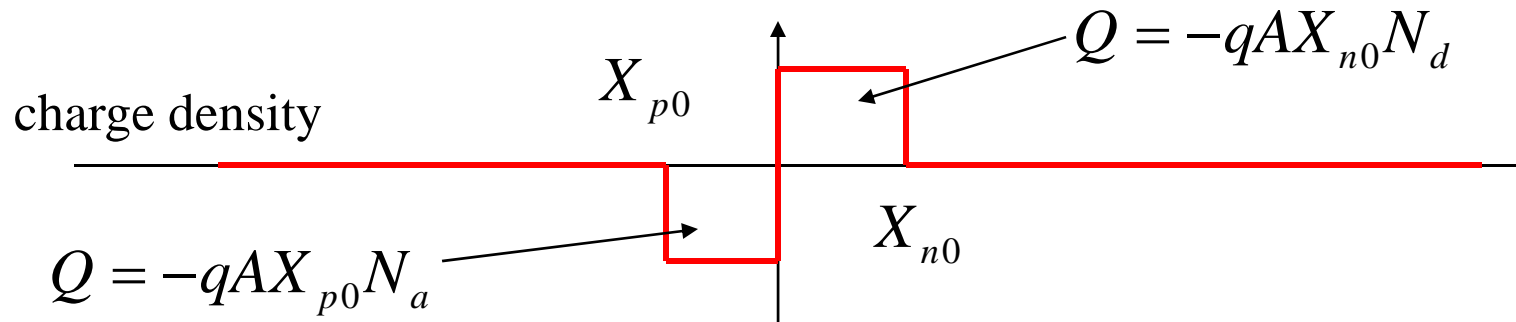

$$X_{p0} = \sqrt{\frac{2\varepsilon\phi_{bi}}{q} \frac{1}{N_a(1+N_a/N_d)}} \rightarrow \sqrt{\frac{2\varepsilon(\phi_{bi}-V)}{q} \frac{1}{N_a(1+N_a/N_d)}}$$

$$Q = -qAX_{p0}N_a = -qAN_a \sqrt{\frac{2\varepsilon(\phi_{bi}-V)}{q} \frac{1}{N_a(1+N_a/N_d)}}$$

$$C = \frac{dQ}{dV} = \frac{A}{2} \sqrt{\frac{2q\varepsilon}{(\phi_{bi}-V)} \frac{N_d N_a}{(N_d + N_a)}}$$

This will be important in high-speed bipolar transistors.

“Short” diodes

p type:

n type:

Calculate n with continuity equation on p-side!

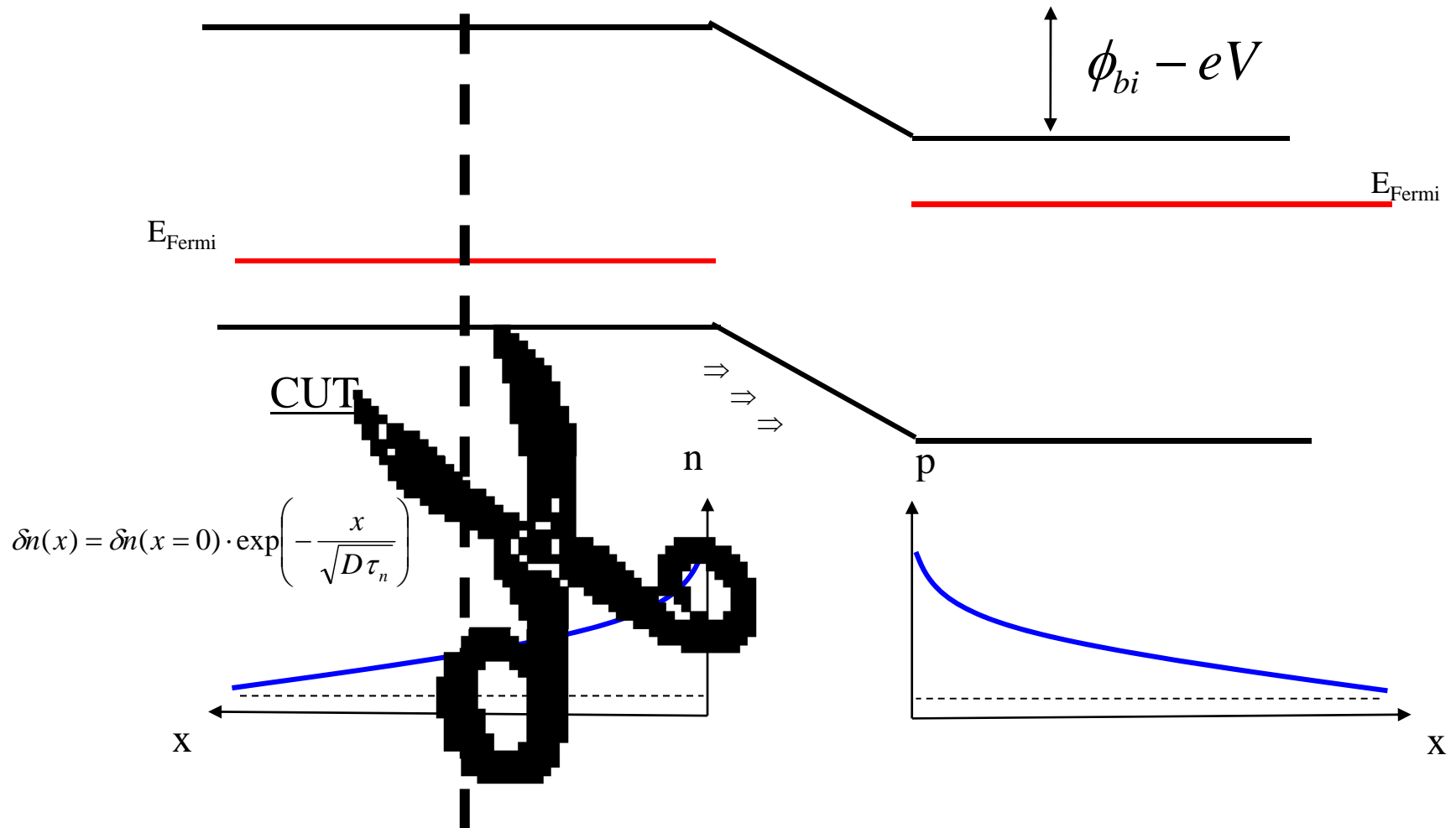

Exactly what we will do with bipolar transistors!

“Short” diodes

$$D \frac{\partial^2 \delta n}{\partial x^2} = \frac{\delta n}{\tau} \quad \Rightarrow \delta n(x) = \delta n(x=0) \cdot \exp\left(-\frac{x}{\sqrt{D\tau_n}}\right)$$

New boundary condition: $\delta n(x = x_B) = 0$

$$\delta n(x) = A \exp\left(-\frac{x}{\sqrt{D\tau_n}}\right) + B \exp\left(+\frac{x}{\sqrt{D\tau_n}}\right)$$

$$\rightarrow (\text{prefactor}) \left(\exp\left(-x/\sqrt{D\tau_n}\right) - \exp\left(+x/\sqrt{D\tau_n}\right) \right)$$

≈ A STRAIGHT LINE

$$\text{If } x_N < \sqrt{D\tau_n}$$

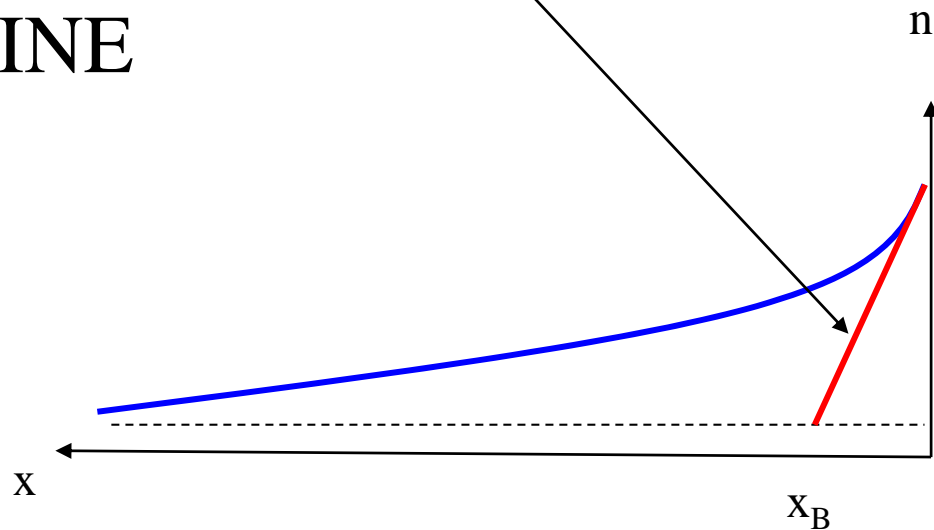

MBE

epitaxial growth

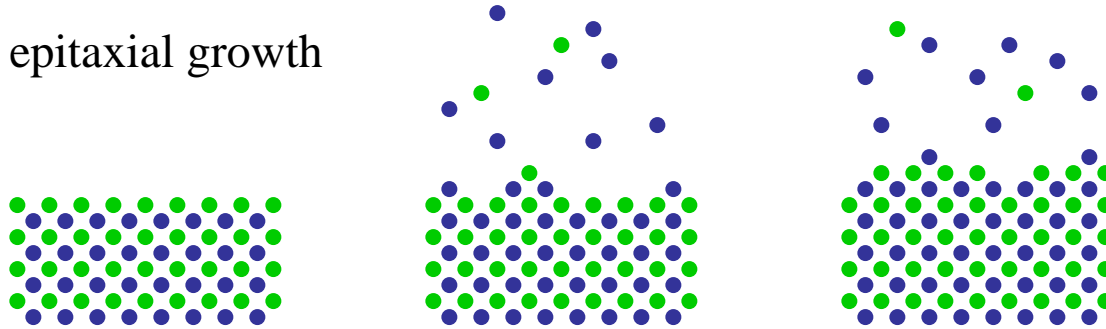

AlAs

GaAs

AlAs

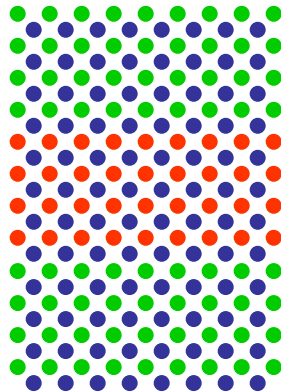

2.2 eV

1.4 eV

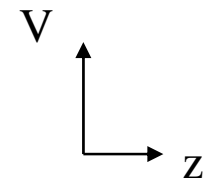
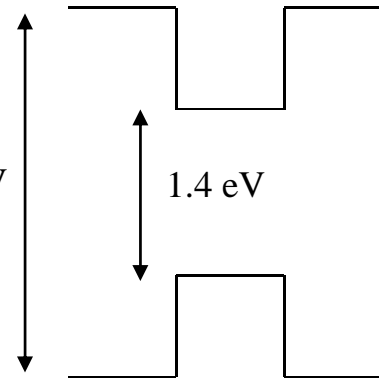

Also InP, InGaAs, InAlAs, InGaAsP ...

Picture adapted from M. Lilly.

MBE

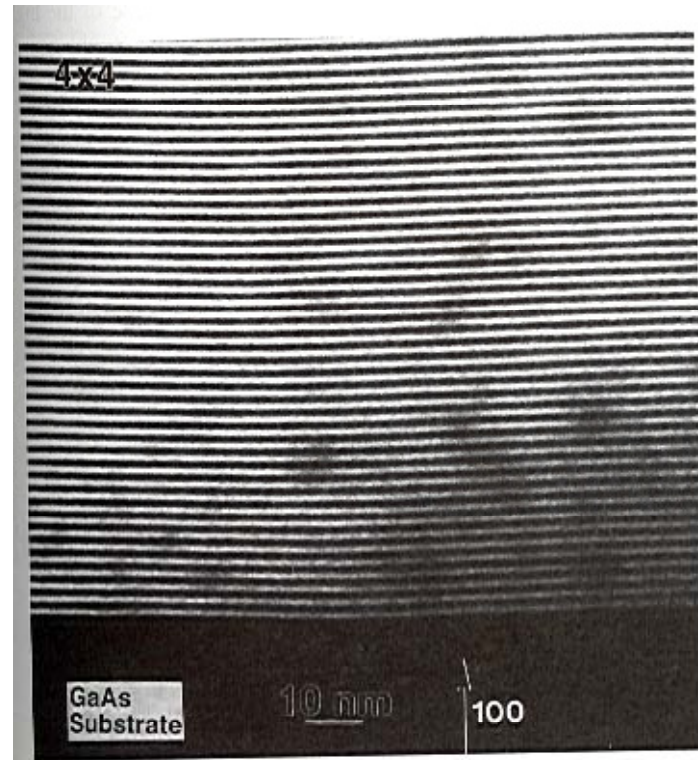
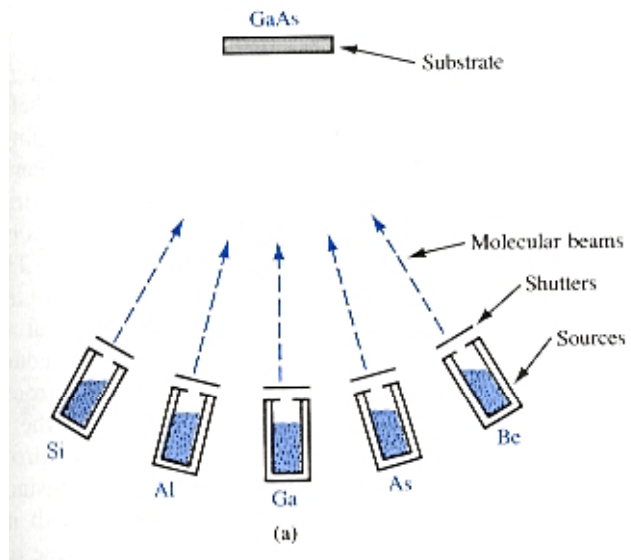

4 atom per layer!

(From Streetman, Solid State Electronic Devices)

Band gaps

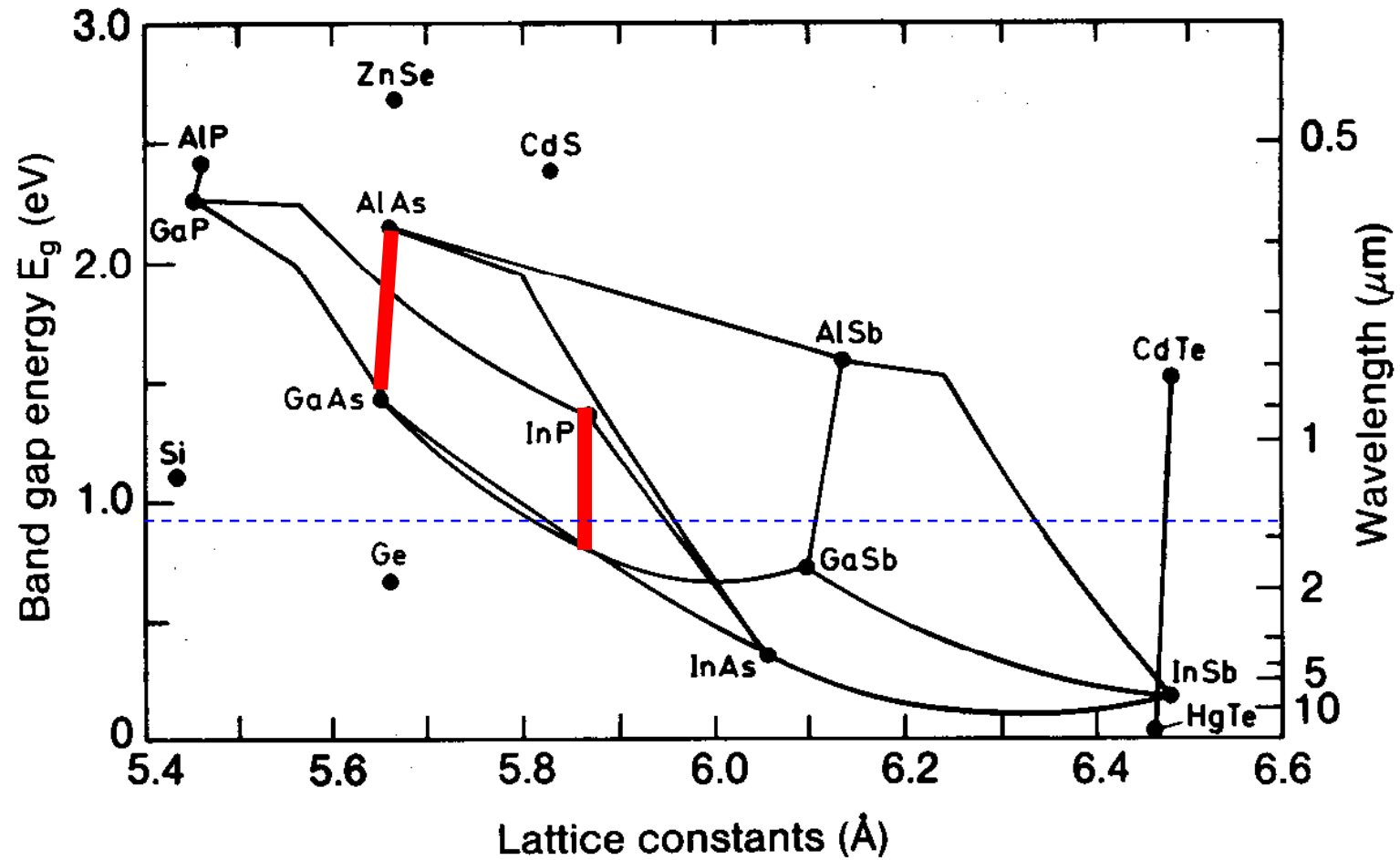

Band gap engineering

$\text{Al}_\xi\text{Ga}_{1-\xi}\text{As}$ Bandgap

(eV)

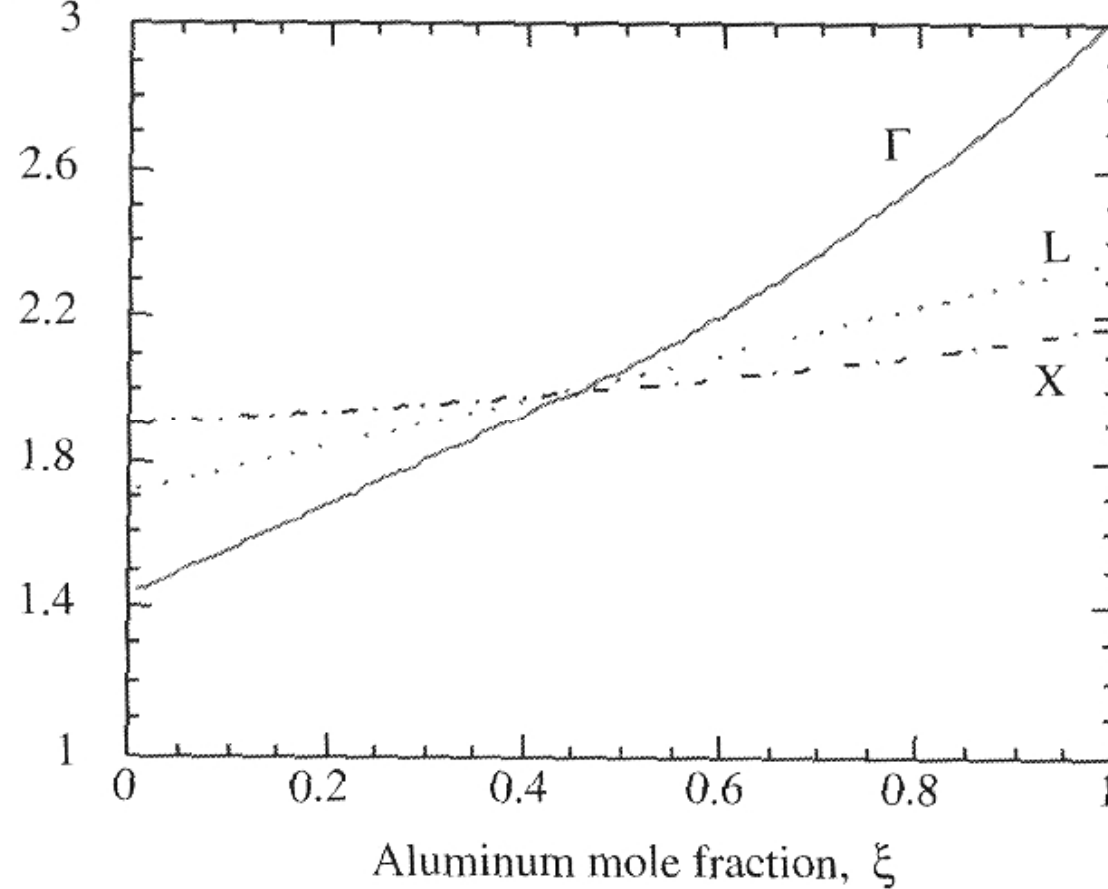

From Liu

Optics

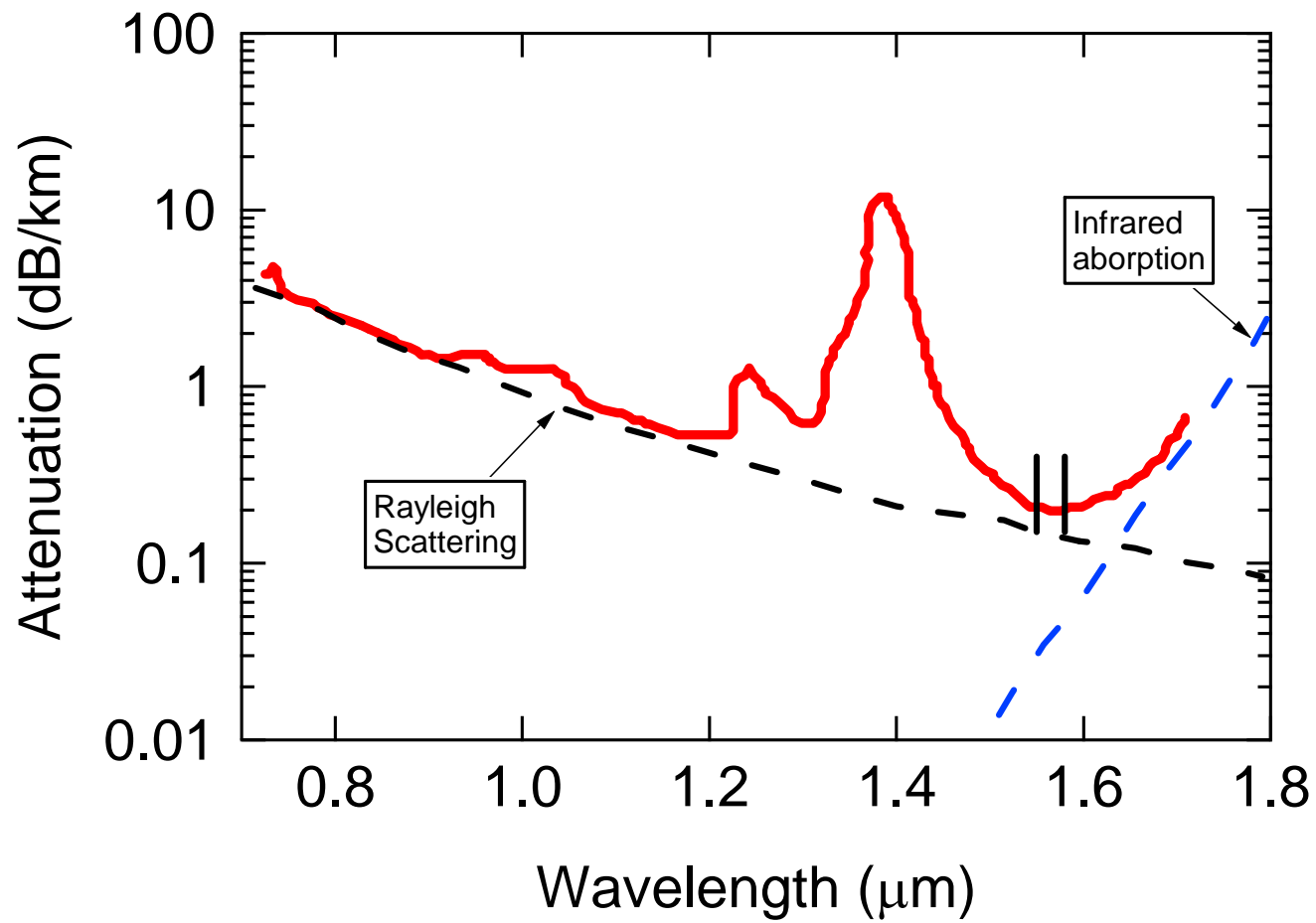

(Adapted from Streetman, Solid State Electronic Devices)

Realistic dispersion curves

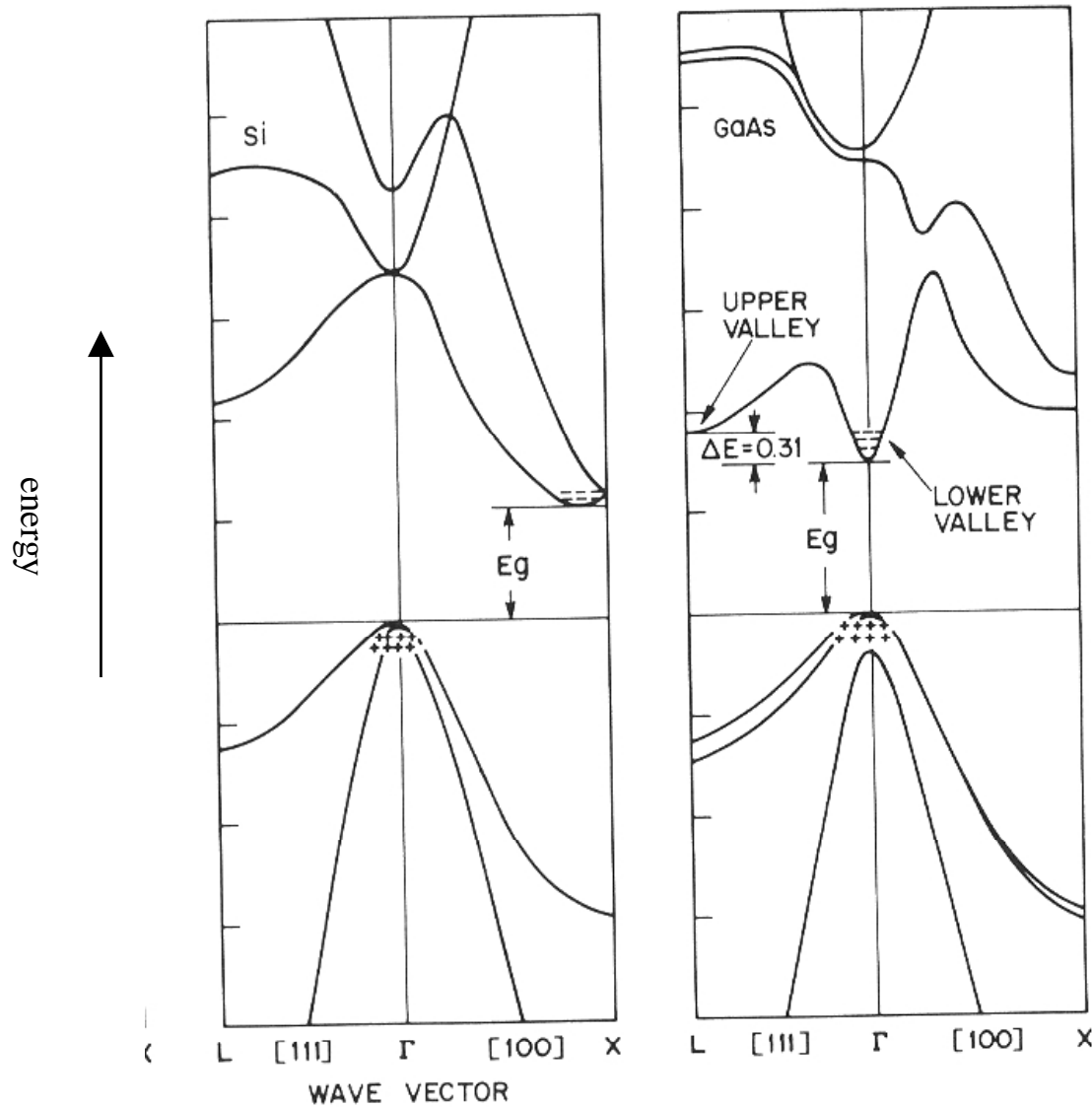

From Sze, Physics of Semiconductor Devices

Heterojunctions

“Vacuum level”

1 Hydrogen atom:

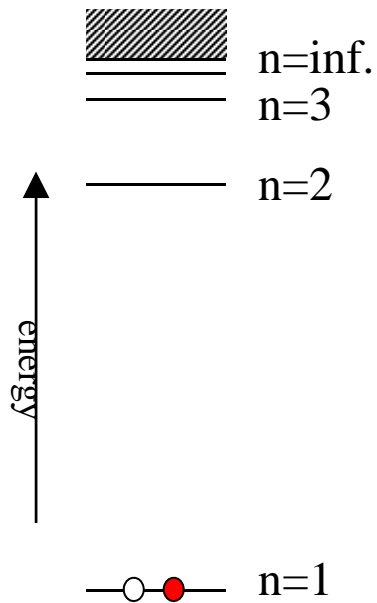

Solid:

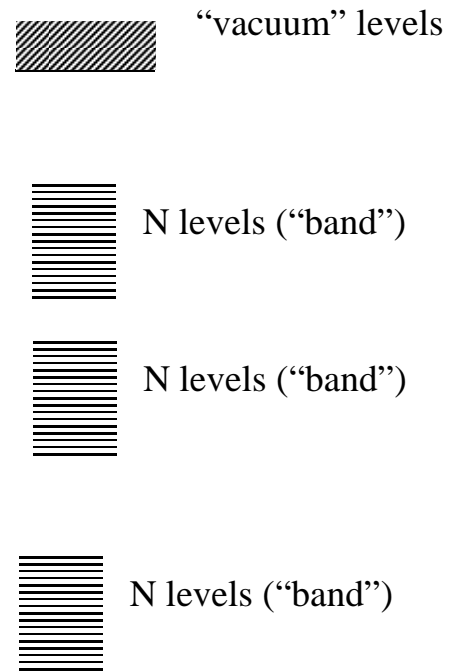

Vacuum level

E_0 _____

E_c _____

E_{Fermi} _____

E_v _____

“electron affinity”



$e\chi = 4.07 \text{ eV}$
in GaAs

$E_g = 1.4 \text{ eV}$
in GaAs

Intrinsic heterojunction

$\text{Al}_{0.3}\text{Ga}_{0.7}\text{As}$

GaAs

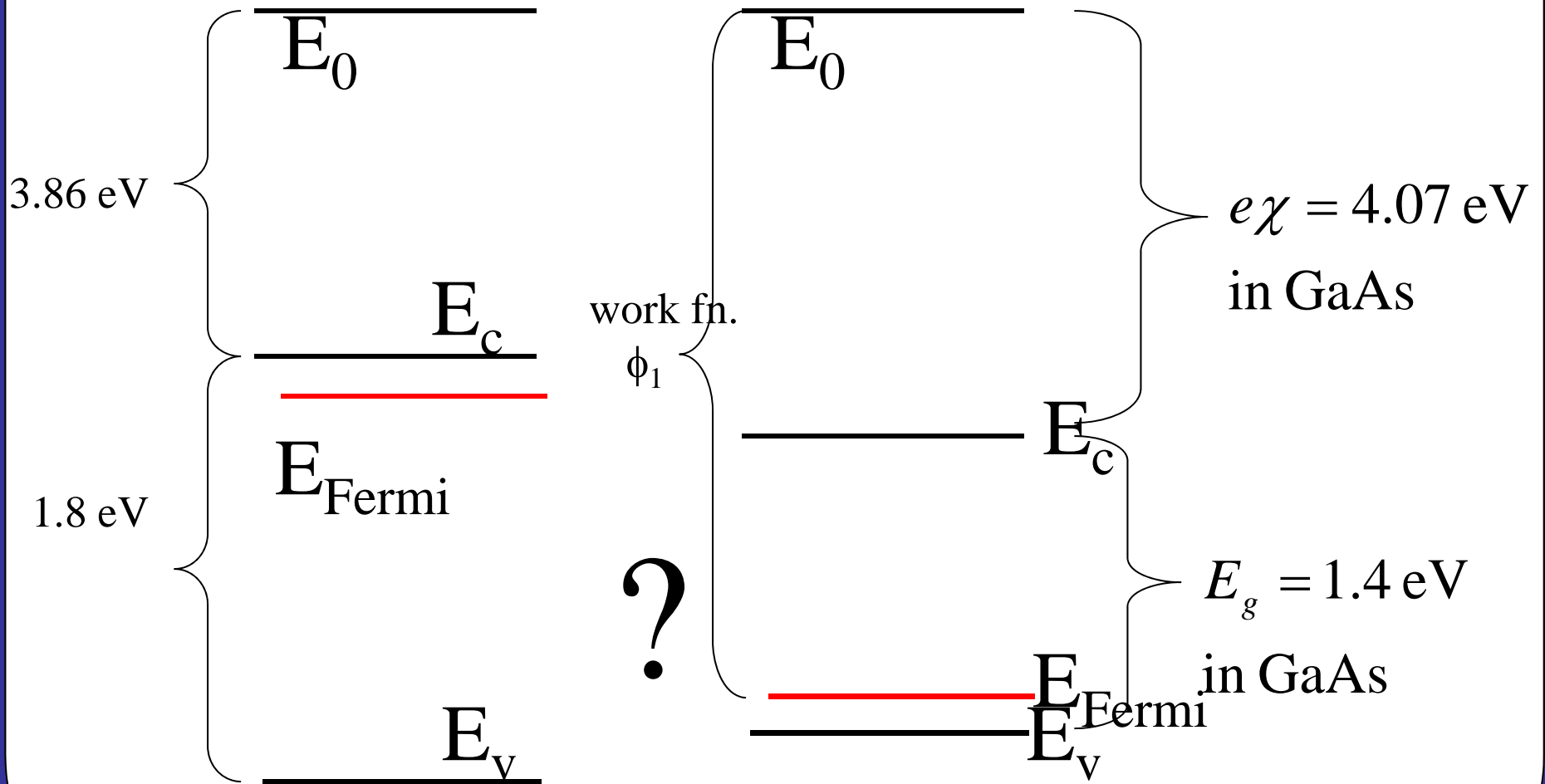

Heterojunction band diagrams

- Determine $\Delta E_c = \chi_1 - \chi_2$
(Vacuum levels line up)
- Determine $\Delta E_v = \Delta E_g - \Delta E_c$
- There will be some charge transfer and built-in electric field/voltage as in p-n homojunction
- Built in voltage $\phi = \phi_1 - \phi_2$
- Draw the diagram (You will in HW#2)
- p-N: capital letter is larger gap side

Determine $\Delta E_c = \chi_1 - \chi_2$

$\text{Al}_{0.3}\text{Ga}_{0.7}\text{As}$

GaAs

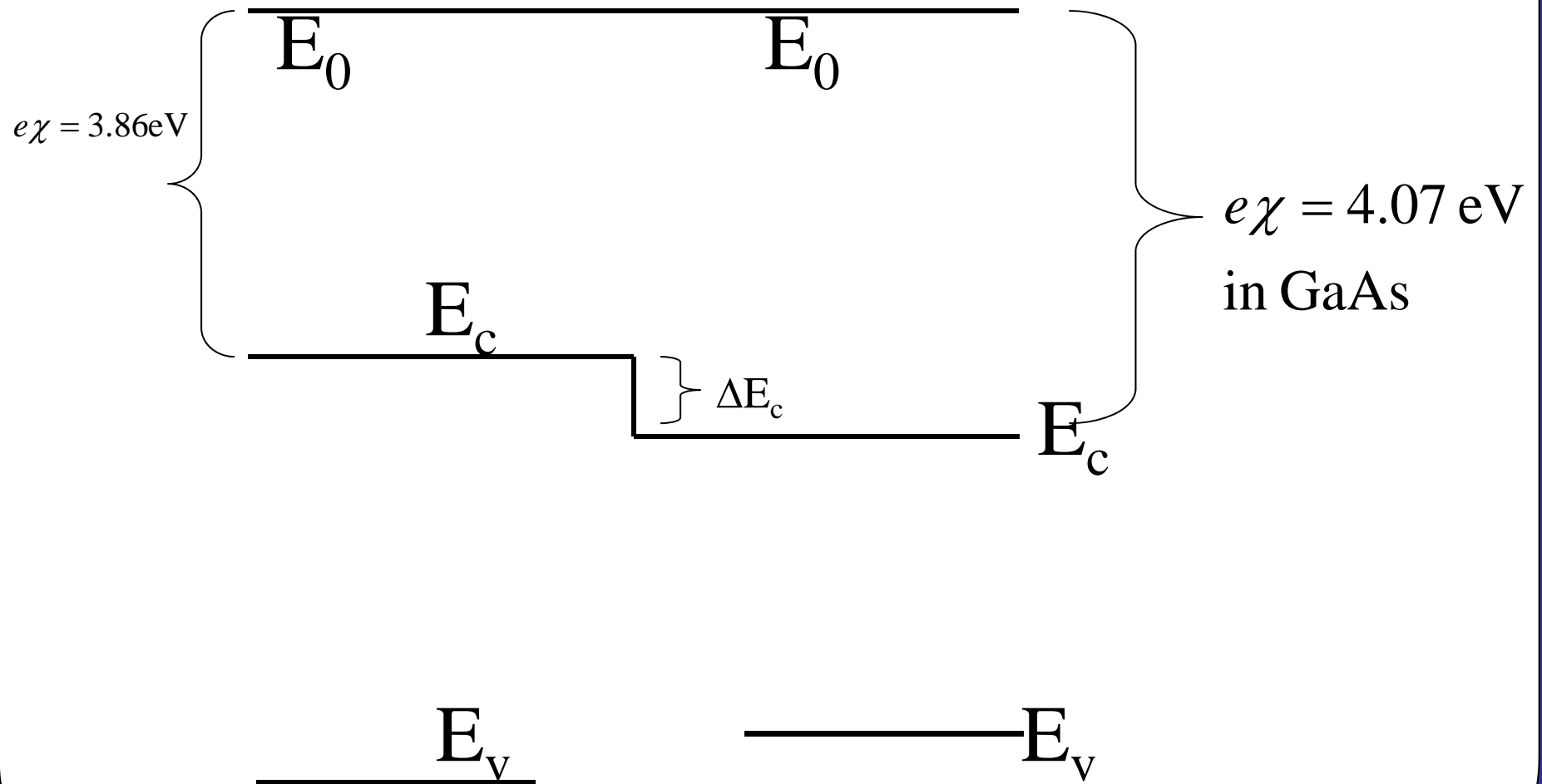

Determine $\Delta E_v = \Delta E_g - \Delta E_c$

$\text{Al}_{0.3}\text{Ga}_{0.7}\text{As}$ GaAs

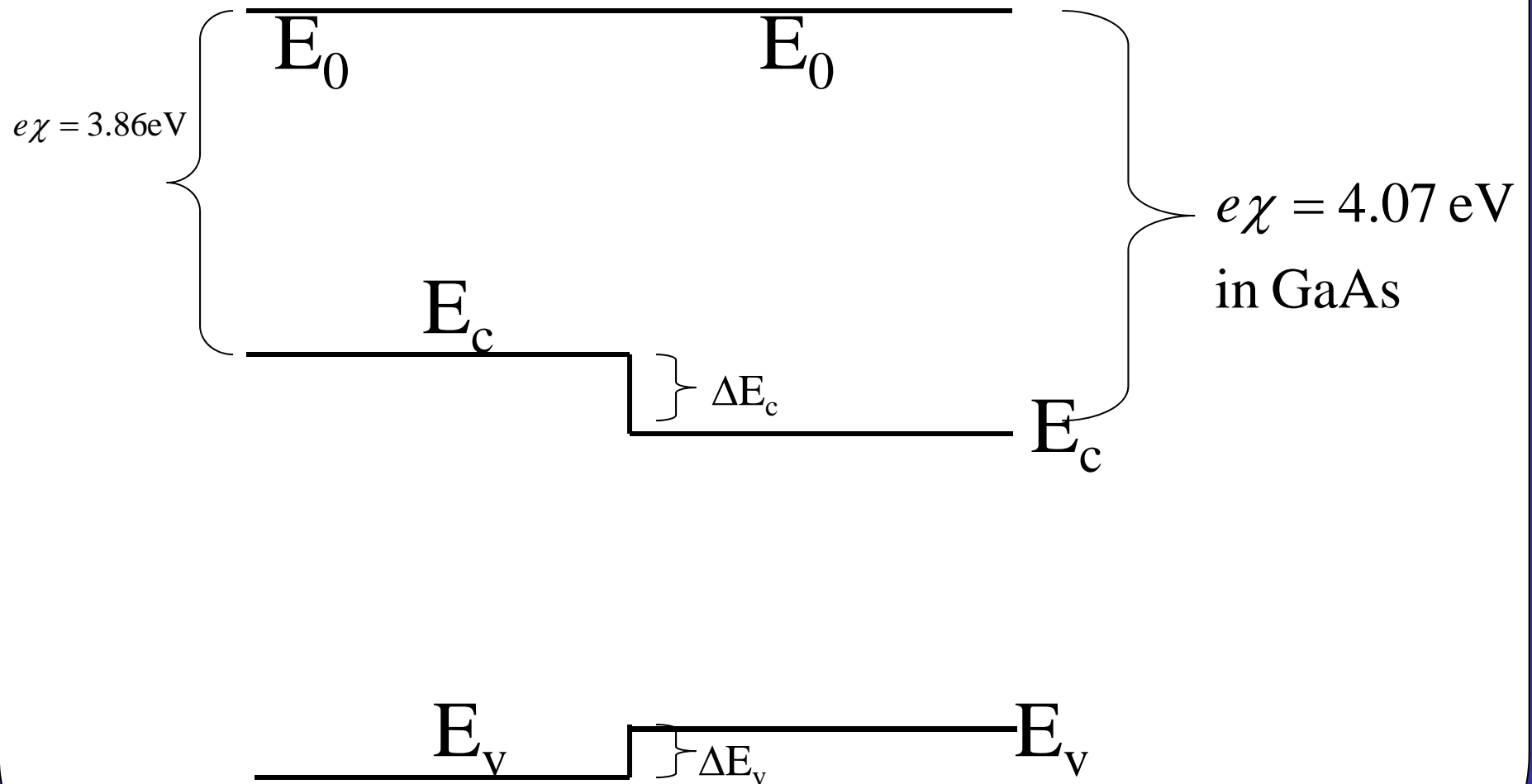

Built in voltage $\phi = \phi_1 - \phi_2$

$\text{Al}_{0.3}\text{Ga}_{0.7}\text{As}$

GaAs

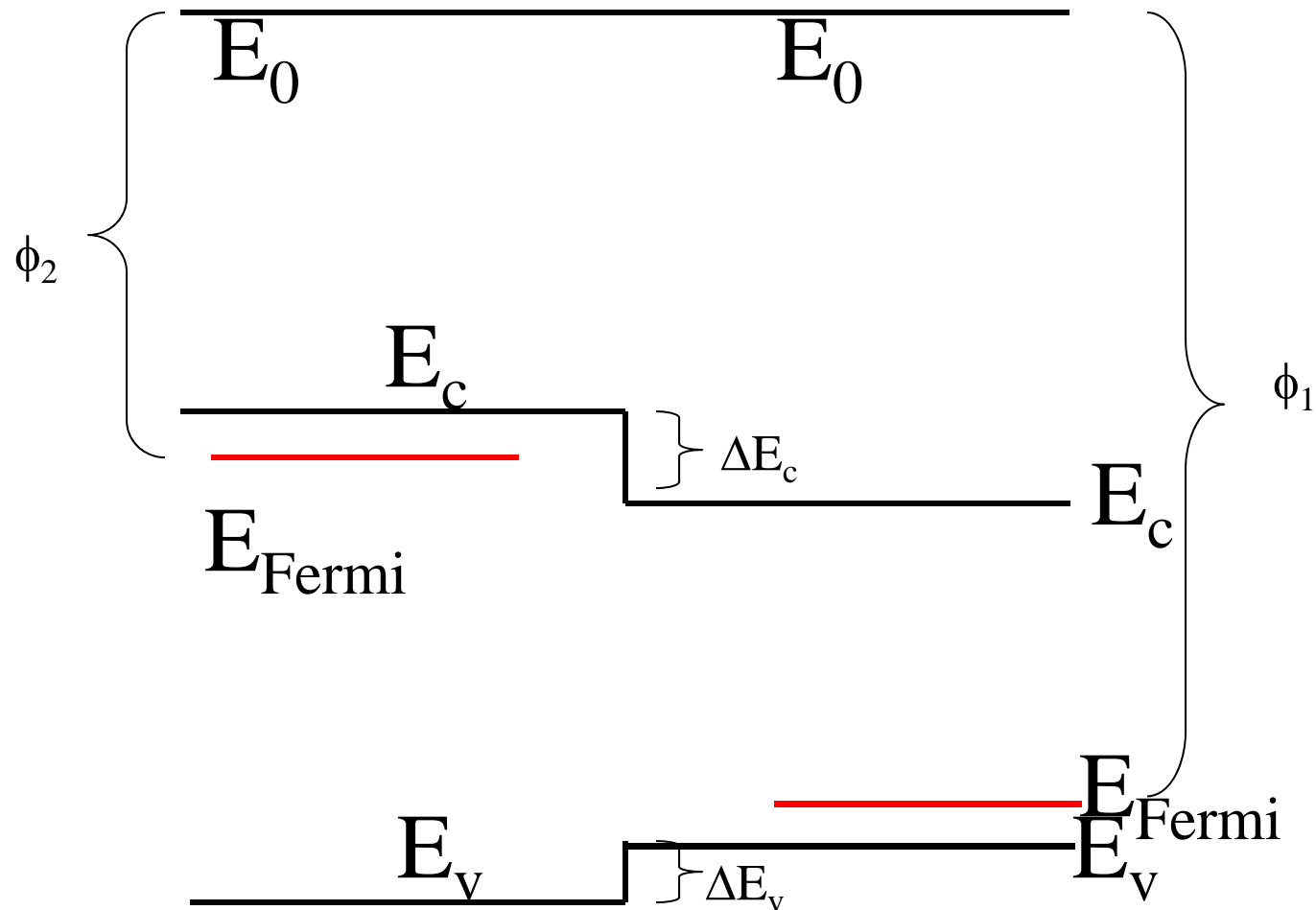

Draw the diagram

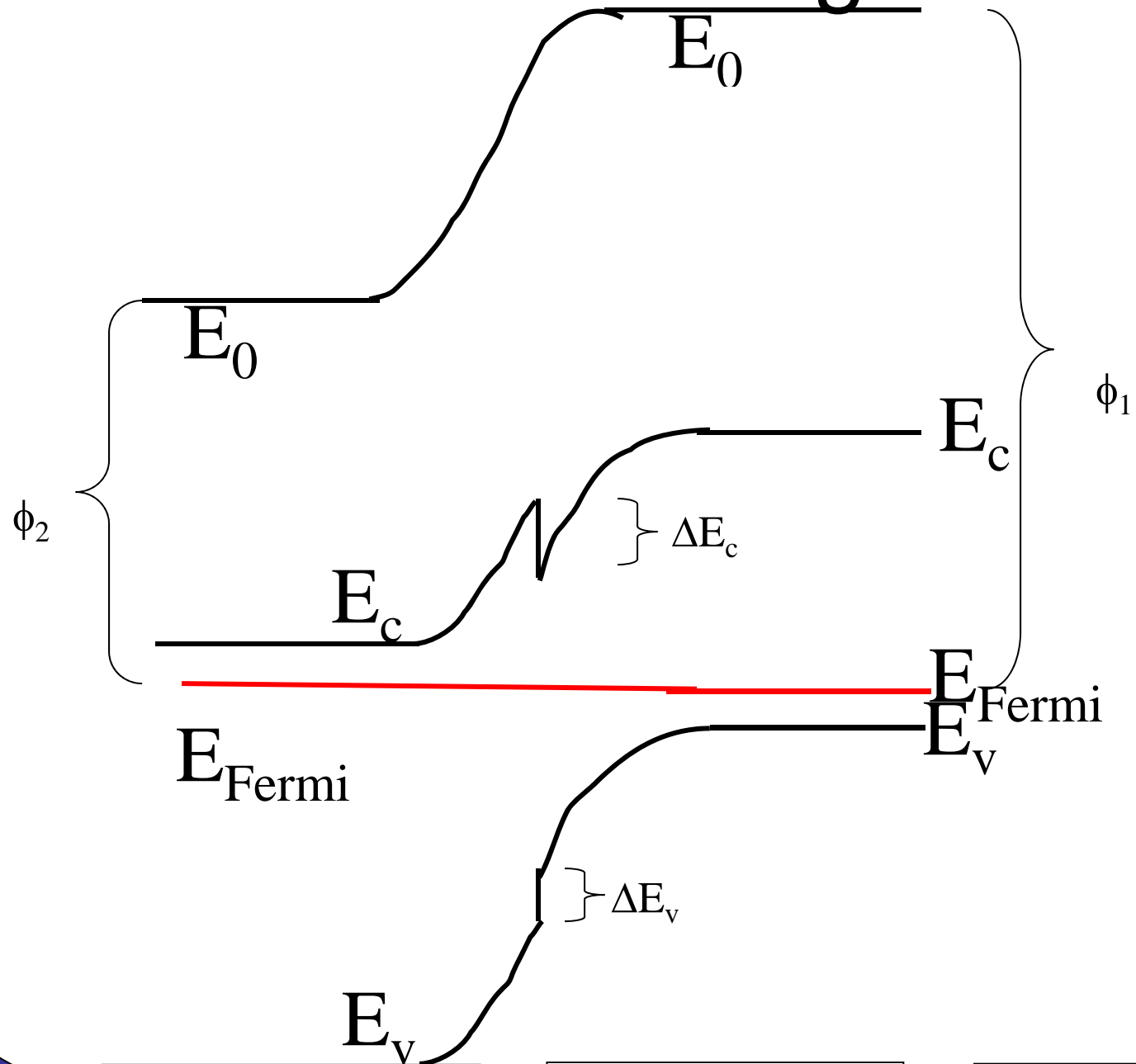

2DEG

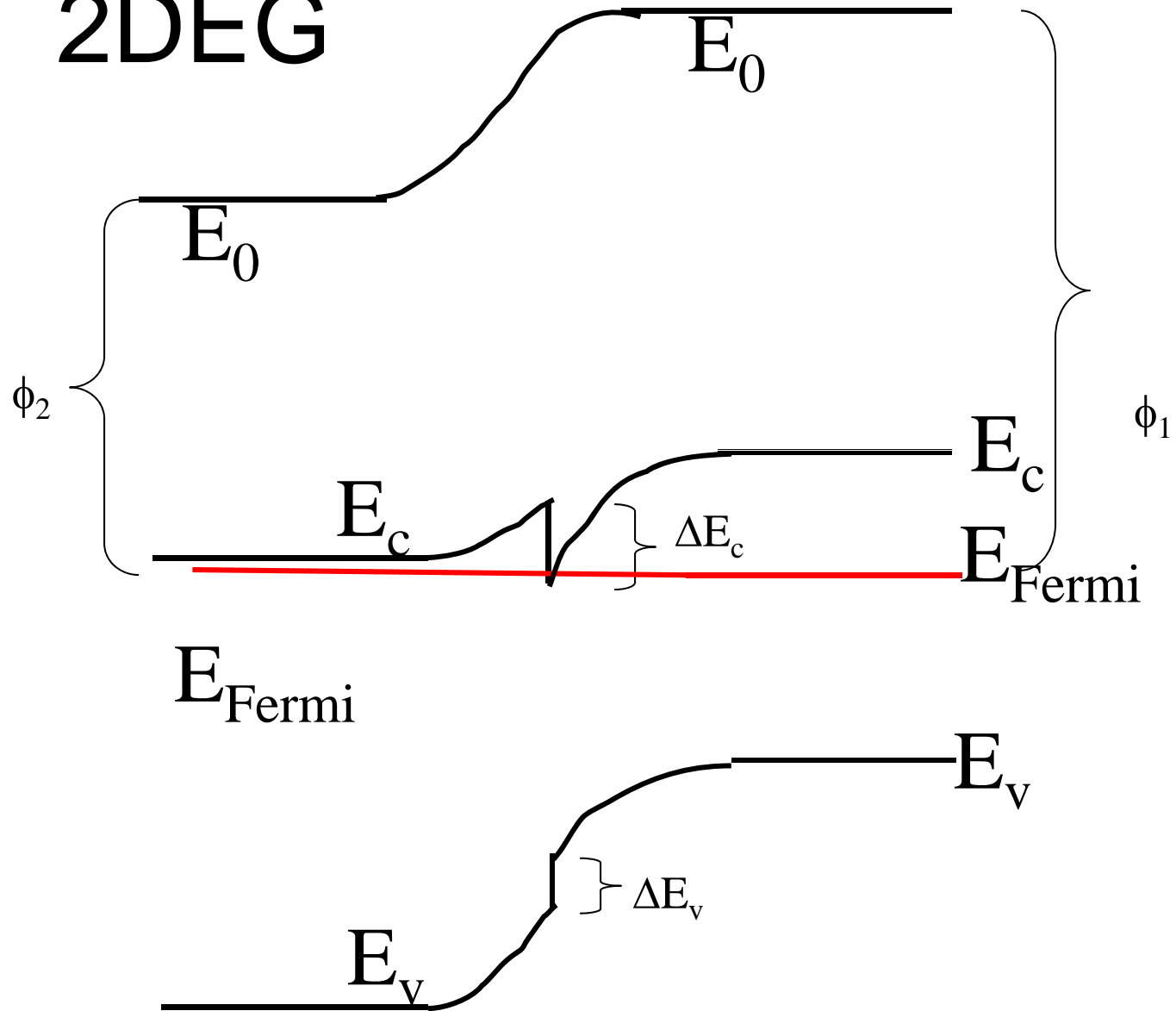

Types

I

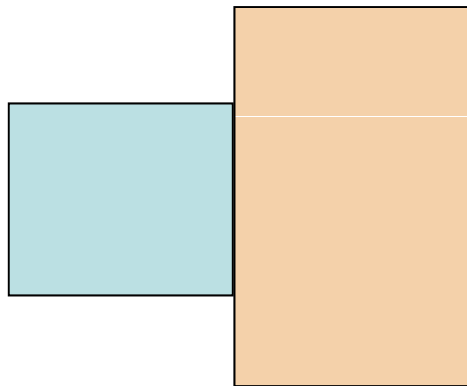

most common

II

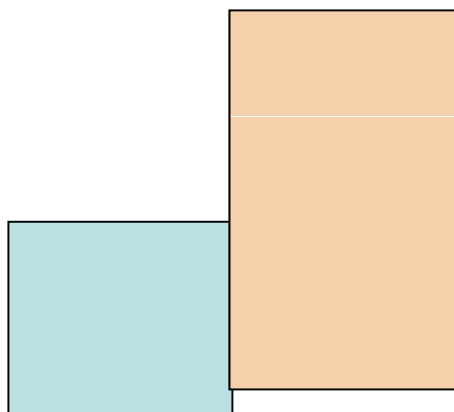

less common

III

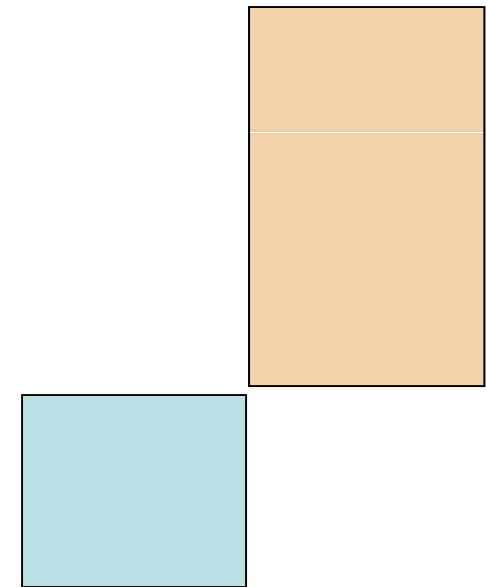

Only GaSb-InAs

Under bias

- Same as p-n homojunction, except for discontinuity in gaps (important for HBT)
- Still have “space charge” or “depletion” region (different dielectric constants in Poisson equation)
- $p^+ N$ most common (because HBT)
- OR: $p N^+$
- OR: $P^+ n$
- OR: $P n^+$

$p^+ N$

- Band diagram at $V=0$ from Liu 2.2
- Band diagram at $V>0$ from Liu 2.11
- Band diagram at $V<0$ from Liu 2.12
- Be sure to discuss asymmetry

$p^+ N$ at $V=0$

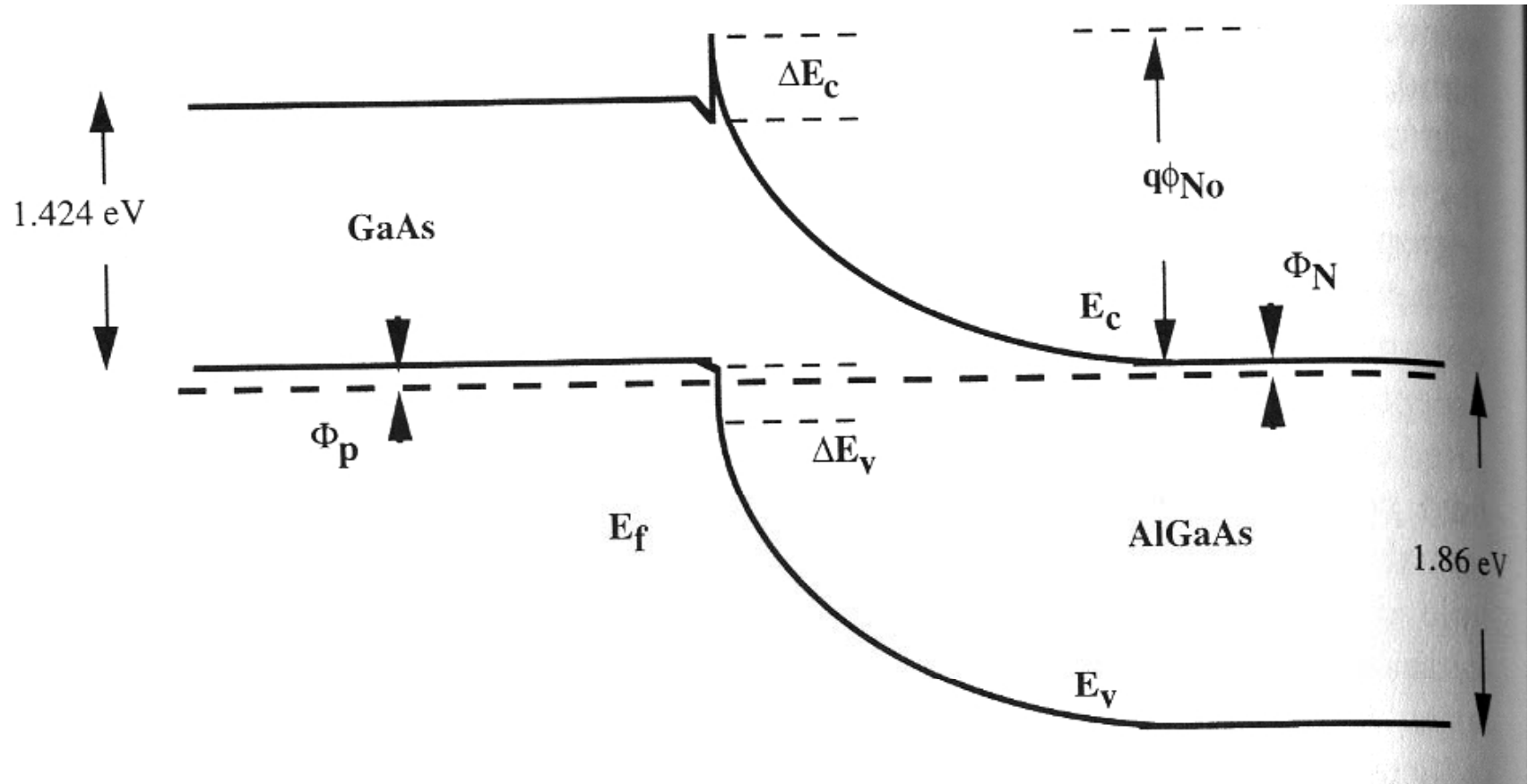

From Liu

$p^+ N$ at $V > 0$

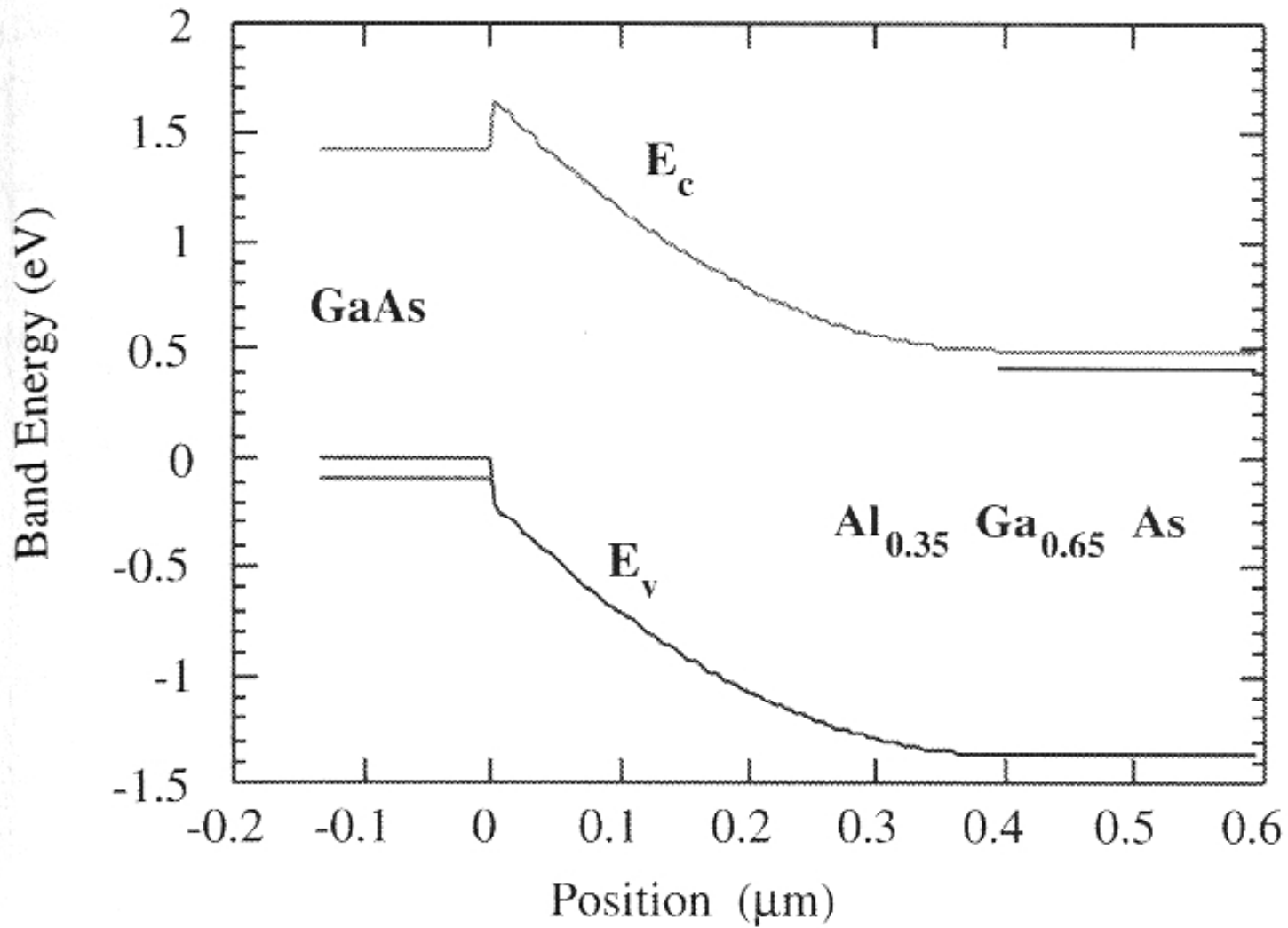

From Liu

$p^+ N$ at $V < 0$

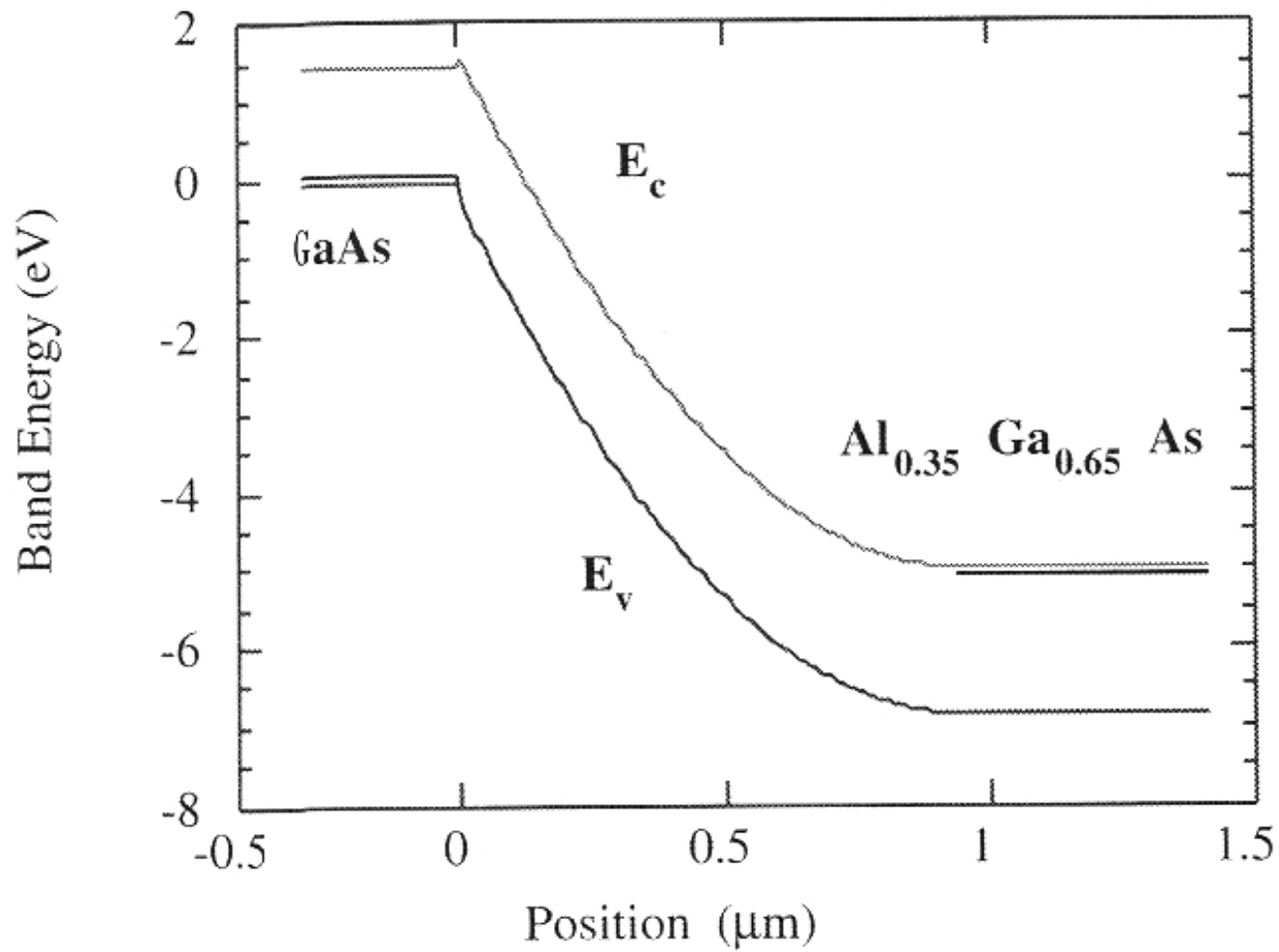

From Liu

Graded heterojunctions

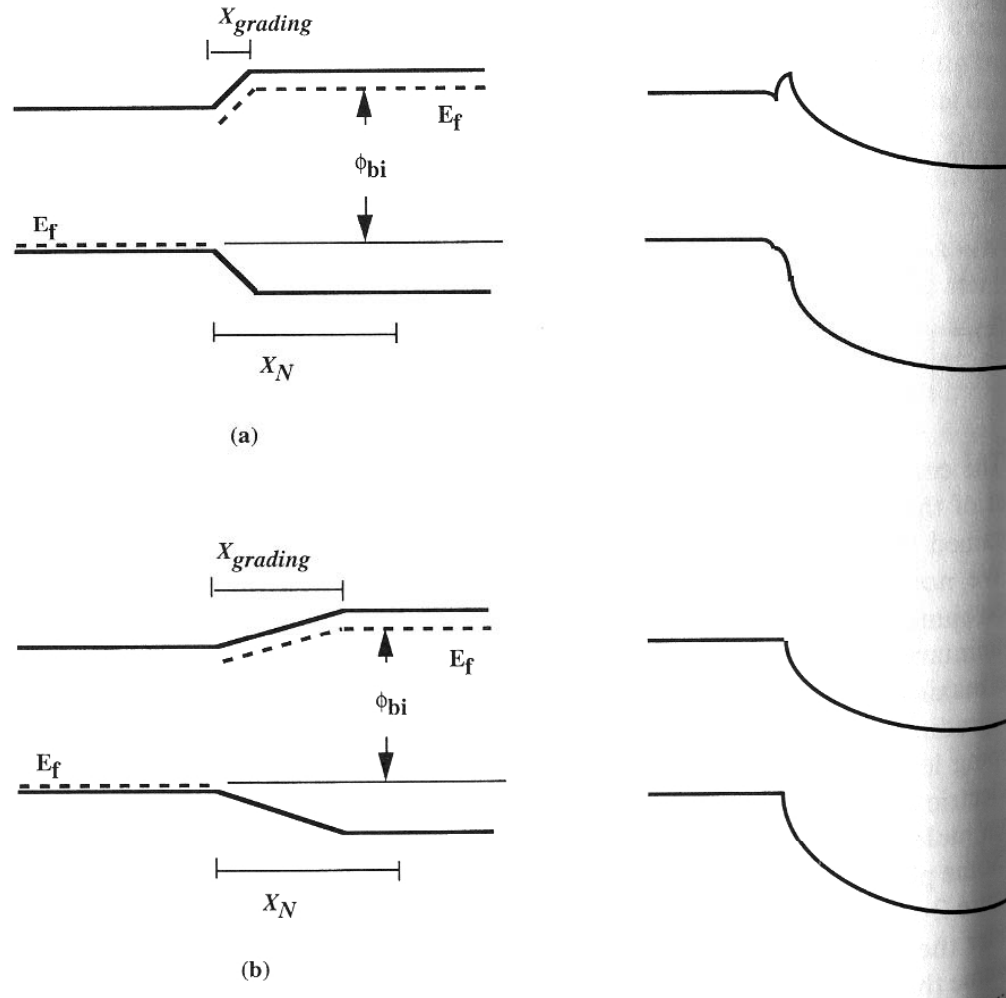

From Liu

Schottky barriers

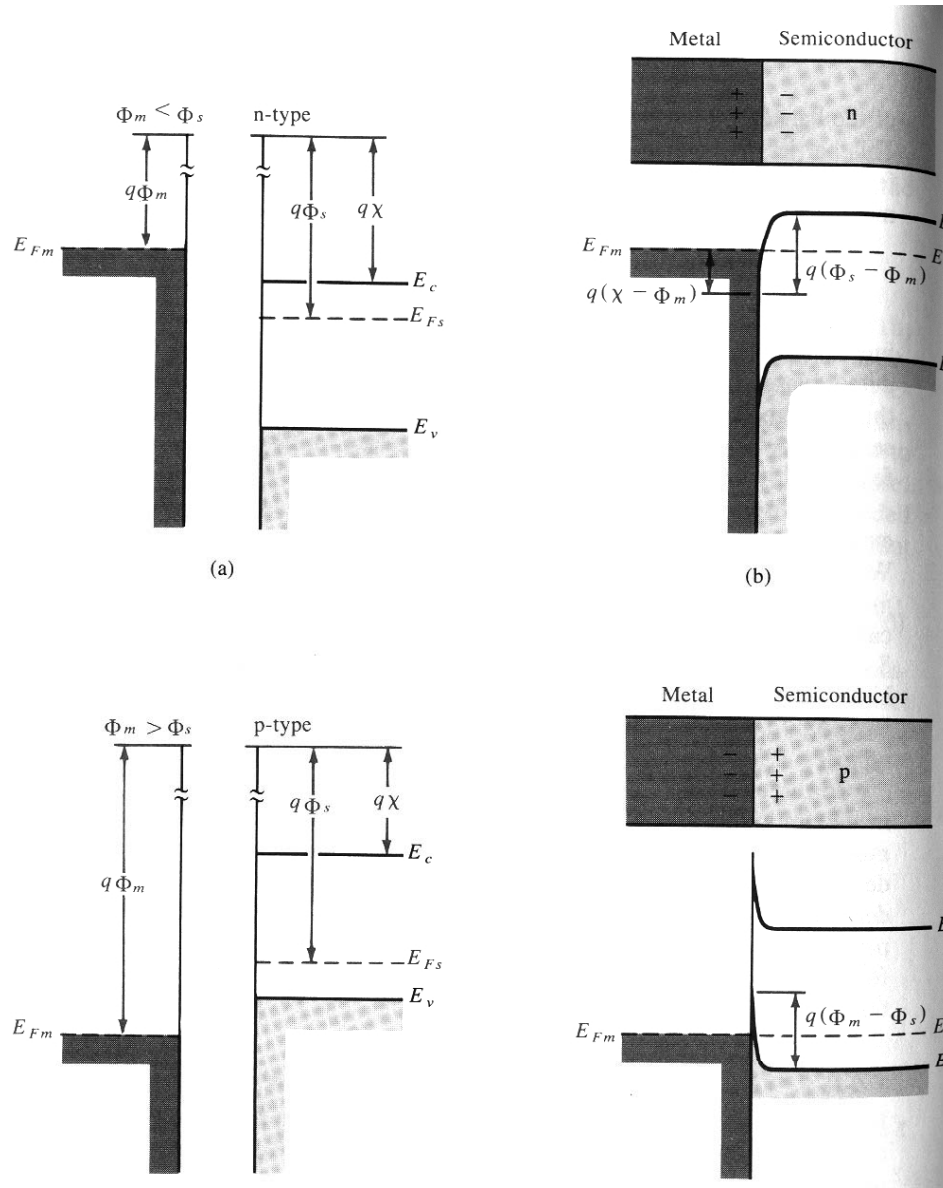

From Streetman

Schottky barriers

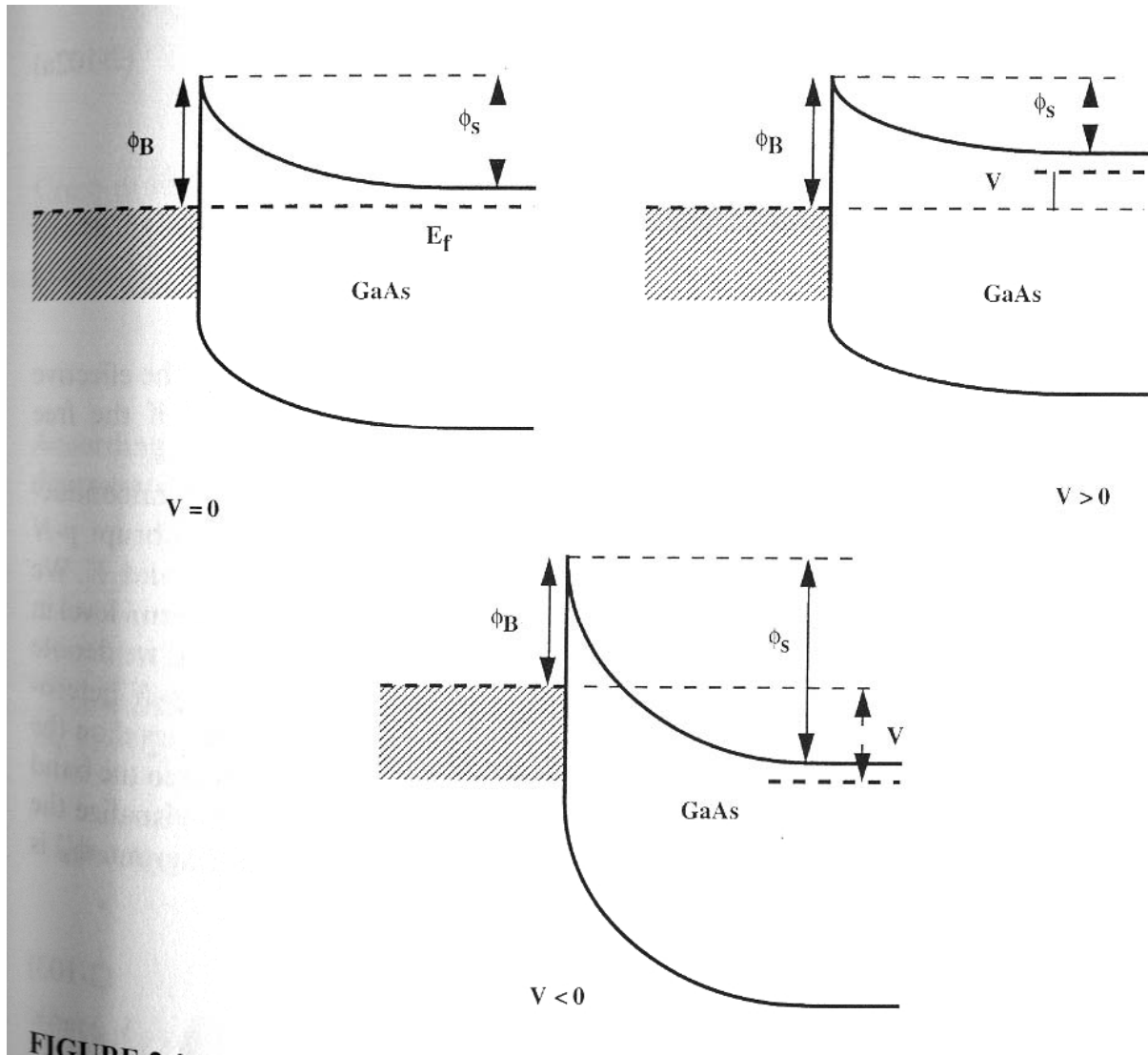

From Liu

Ohmic contact

Not on HW but obviously very important in real life.

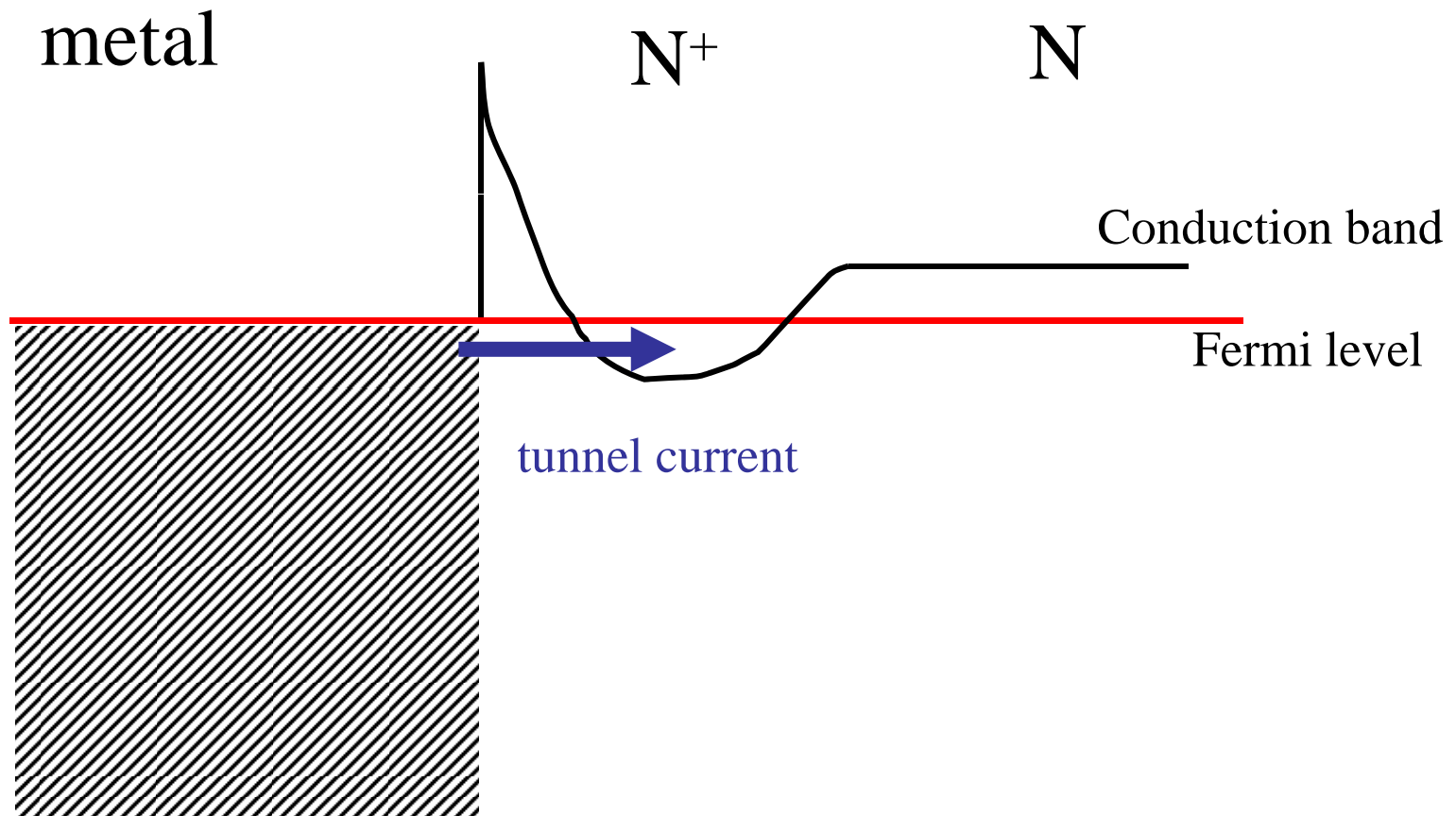

Ohmic contact

- Not always contacting bulk (e.g. 2DEG)
- A technique to improve: anneal
Metal diffuses into semiconductor
- Experimental science
- Typically 400-450 C for 30 sec. to 10 min.
- Rapid anneal better
- Au/Ni/Ge best for GaAs
- Typically 10^{-6} ohm-cm²
(discuss units on board)

p⁺ N I-V curve

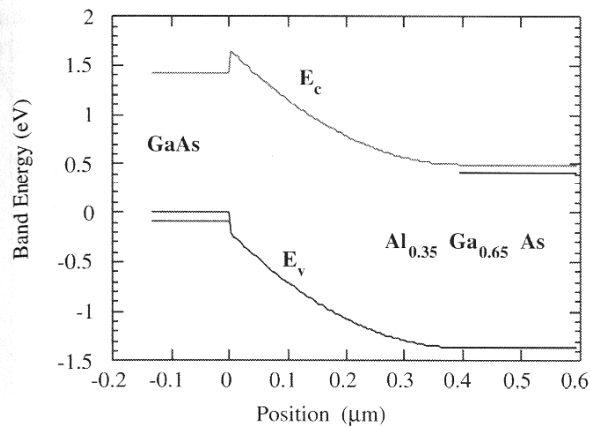

From Liu

As in p-n homojunction:
 Diffusion current: Electrons with energy $> eV_0$
 Exponentially increased. (Explain).
 Drift current :not really effected.

$$I = I_{diffusion} - |I_{drift}|$$

exponentially larger \rightarrow $I_{diffusion}$ \leftarrow about the same I_{drift}

$$I = I_0 \left(e^{qV/kT} - 1 \right) \rightarrow I_0 \left(e^{qV_n/kT} - 1 \right)$$

But only voltage drop across N region matters

$$I = I_0 \left(\exp \left[\frac{qV}{kT} \frac{1}{1+K} \right] - 1 \right)$$

$$K = \frac{\epsilon_N N_d}{\epsilon_p N_a}$$

Grated p⁺ N I-V curve

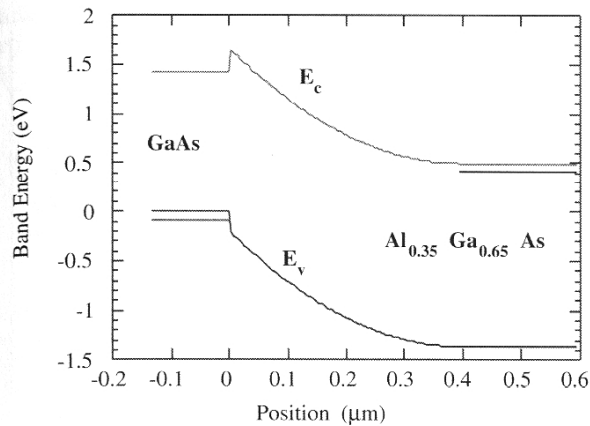

As in p-n homojunction
but MORE CURRENT

From Liu

$$I = I_{diffusion} - |I_{drift}|$$

exponentially larger

about the same

$$I = I_0 \left(e^{qV/kT} - 1 \right)$$

I_0 larger in grated p⁺N than in abrupt p⁺N.