

Lecture 8: 2-dimensional electron gas (2DEG)

2DEG

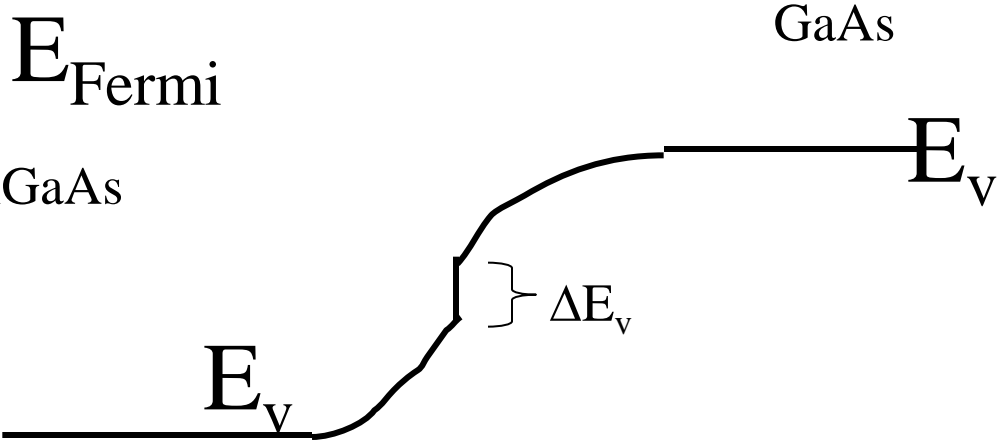
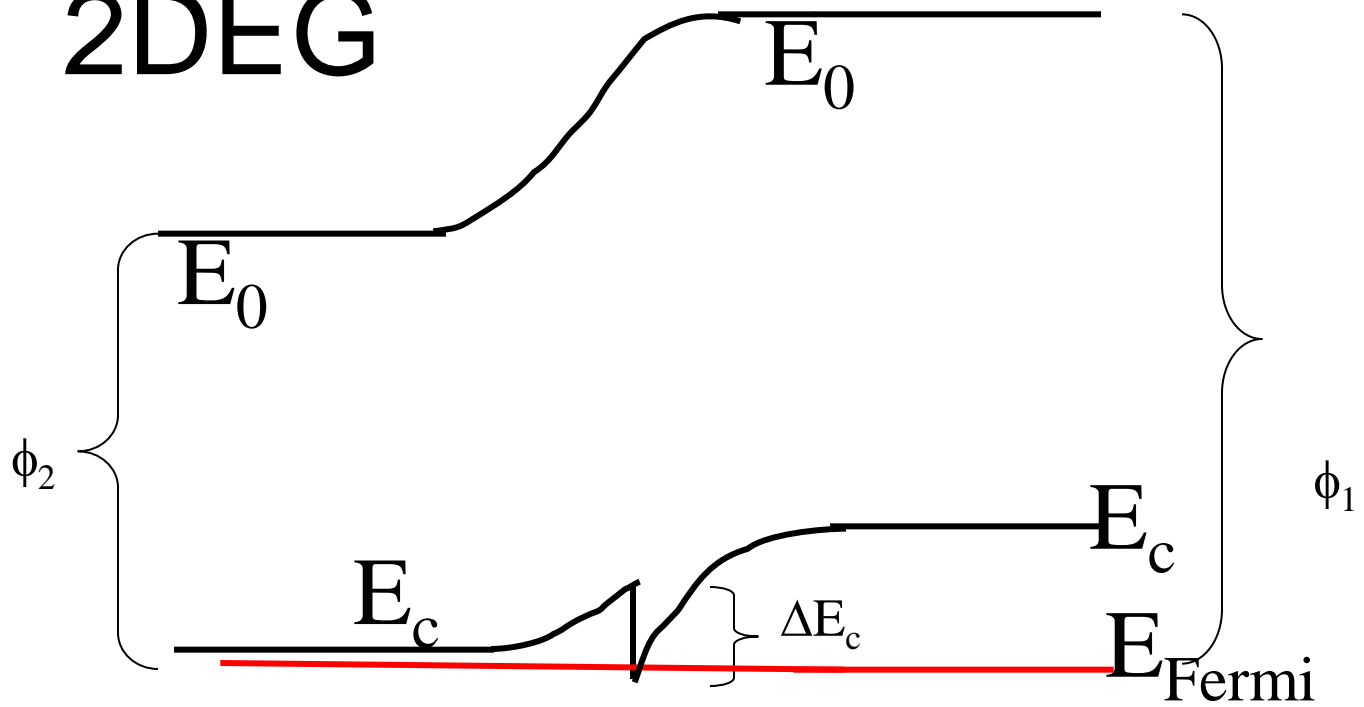

2DEG

- Two-dimensional electron gas
- Treat as free-electrons
- But, they are “confined” in the third dimension.

MBE

epitaxial growth

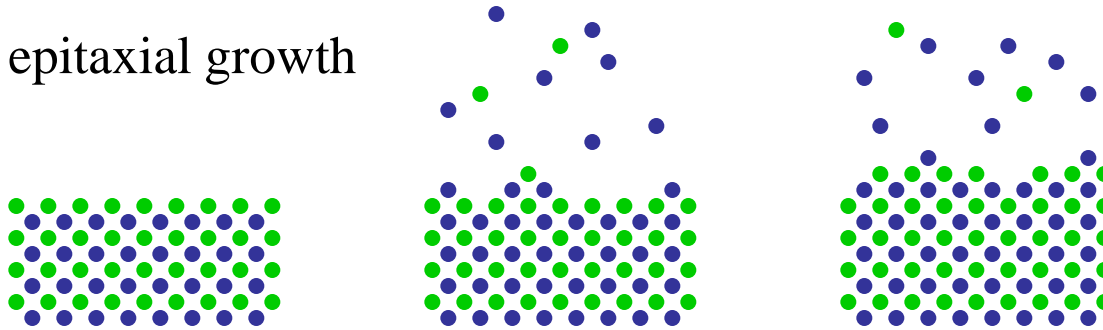

AlAs

GaAs

AlAs

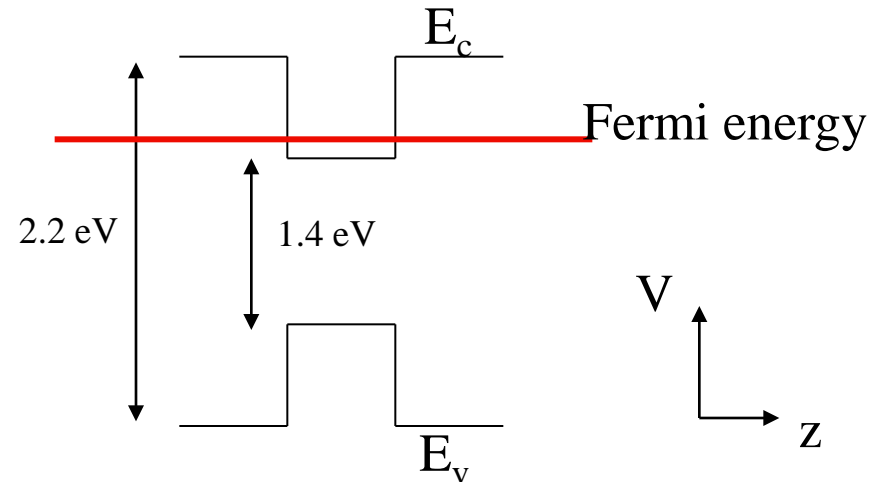
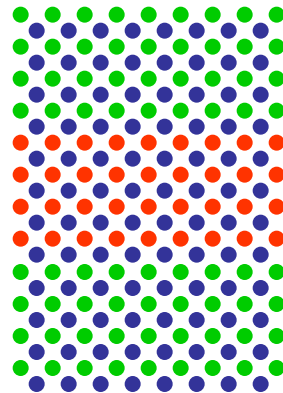

This is square well. We will approximate as infinitely high (i.e. box)
Discuss on board.

Boundary conditions:

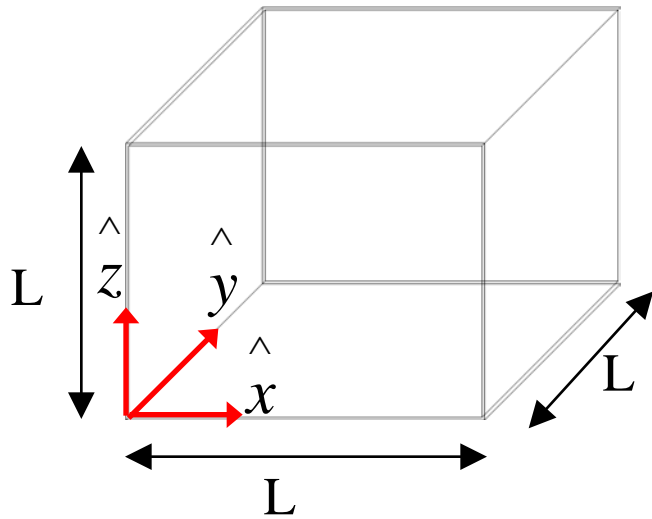

$$\psi(\vec{r}) = (2i)^3 A \cdot \sin(k_{n_x} x) \cdot \sin(k_{n_y} y) \cdot \sin(k_{n_z} z)$$

This satisfies boundary conditions.

$$k_{n_x} = n_x \pi / L$$

$$k_{n_y} = n_y \pi / L$$

$$k_{n_z} = n_z \pi / L$$

$$E = \frac{\hbar^2 (k_{n_x}^2 + k_{n_y}^2 + k_{n_z}^2)}{2m} = \frac{\hbar^2 (\pi / L)^2}{2m} (n_x^2 + n_y^2 + n_z^2)$$

These are the allowed energy levels, or “quantum states”

Confinement in z dimension

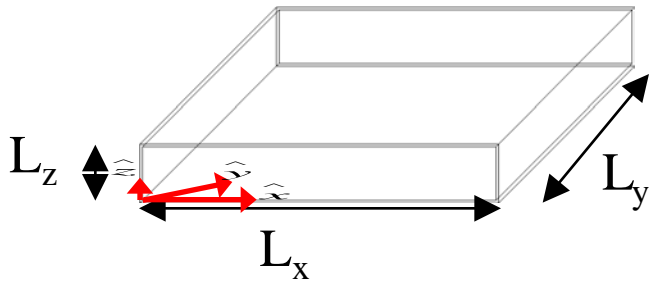

$$\psi(\vec{r}) = (2i)^3 A \cdot \sin(k_{n_x} x) \cdot \sin(k_{n_y} y) \cdot \sin(k_{n_z} z)$$

$$k_{n_x} = n_x \pi / L_x$$

$$k_{n_y} = n_y \pi / L_y$$

$$k_{n_z} = n_z \pi / L_z$$

$$E = \frac{\hbar^2 (k_{n_x}^2 + k_{n_y}^2 + k_{n_z}^2)}{2m} \neq \frac{\hbar^2 (\pi / L)^2}{2m} (n_x^2 + n_y^2 + n_z^2)$$

$$\rightarrow \frac{\hbar^2 (\pi / L_z)^2}{2m} (n_z^2) + \frac{\hbar^2 (\pi / L)^2}{2m} (n_x^2 + n_y^2)$$

$$\rightarrow \text{constant} + \frac{\hbar^2 (\pi / L)^2}{2m} (n_x^2 + n_y^2)$$

Energy spectrum of free particles:

3 dimensions

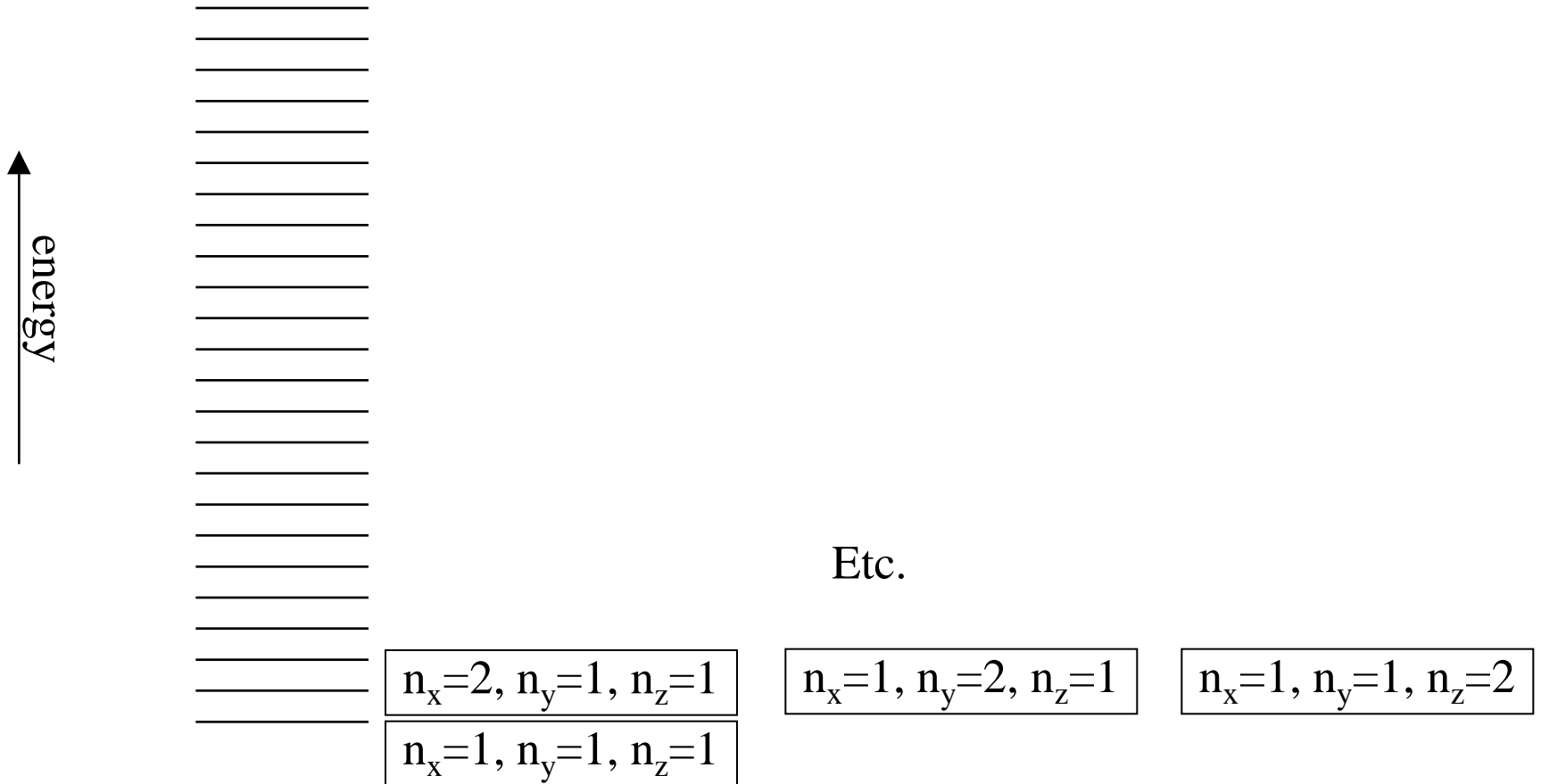

Energy spectrum of free particles:

2 dimensions

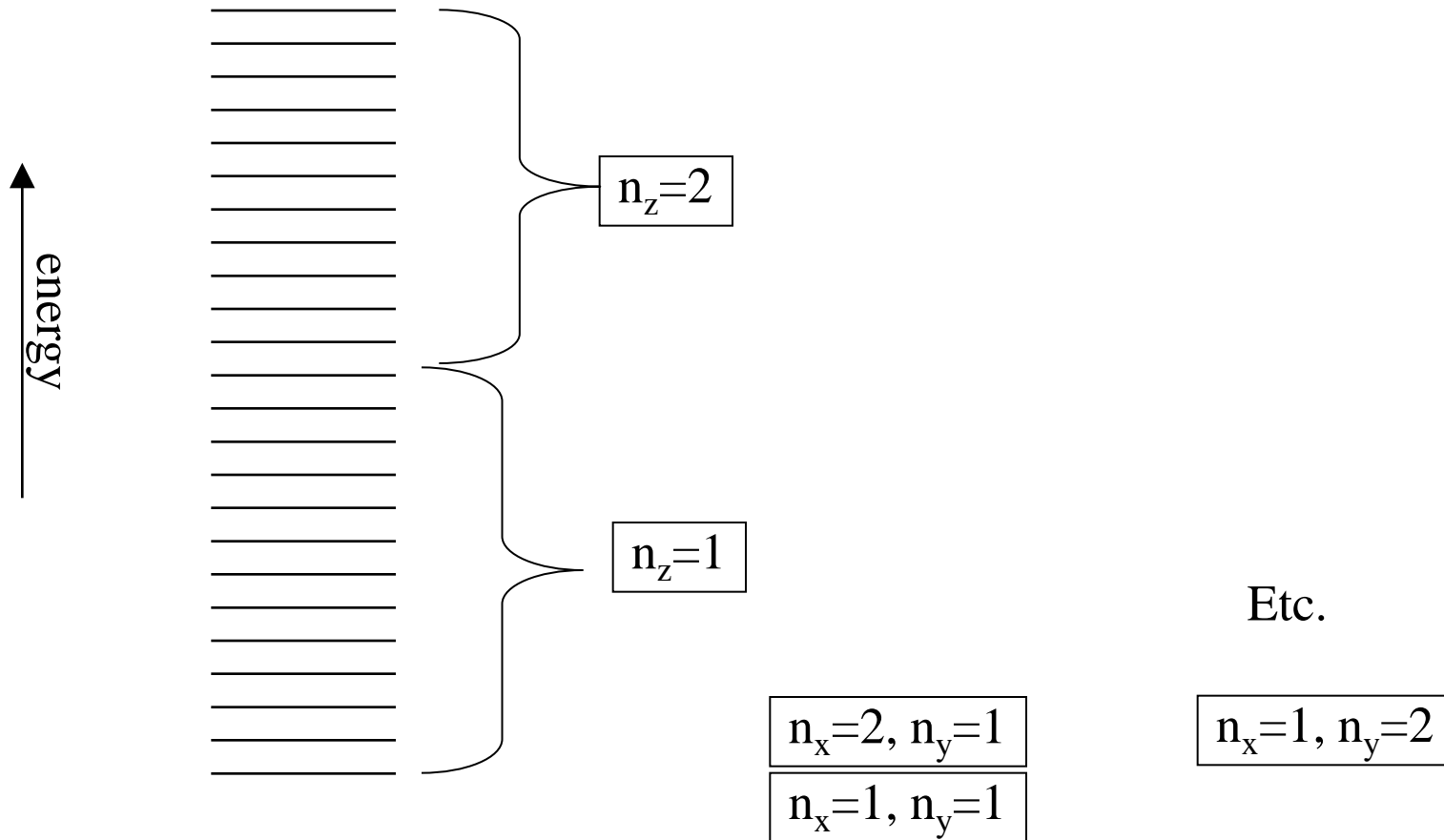

Density of states:

Different for 2, 3 dimensions.

If L is large, states are very close together.
Approximate as a continuum.

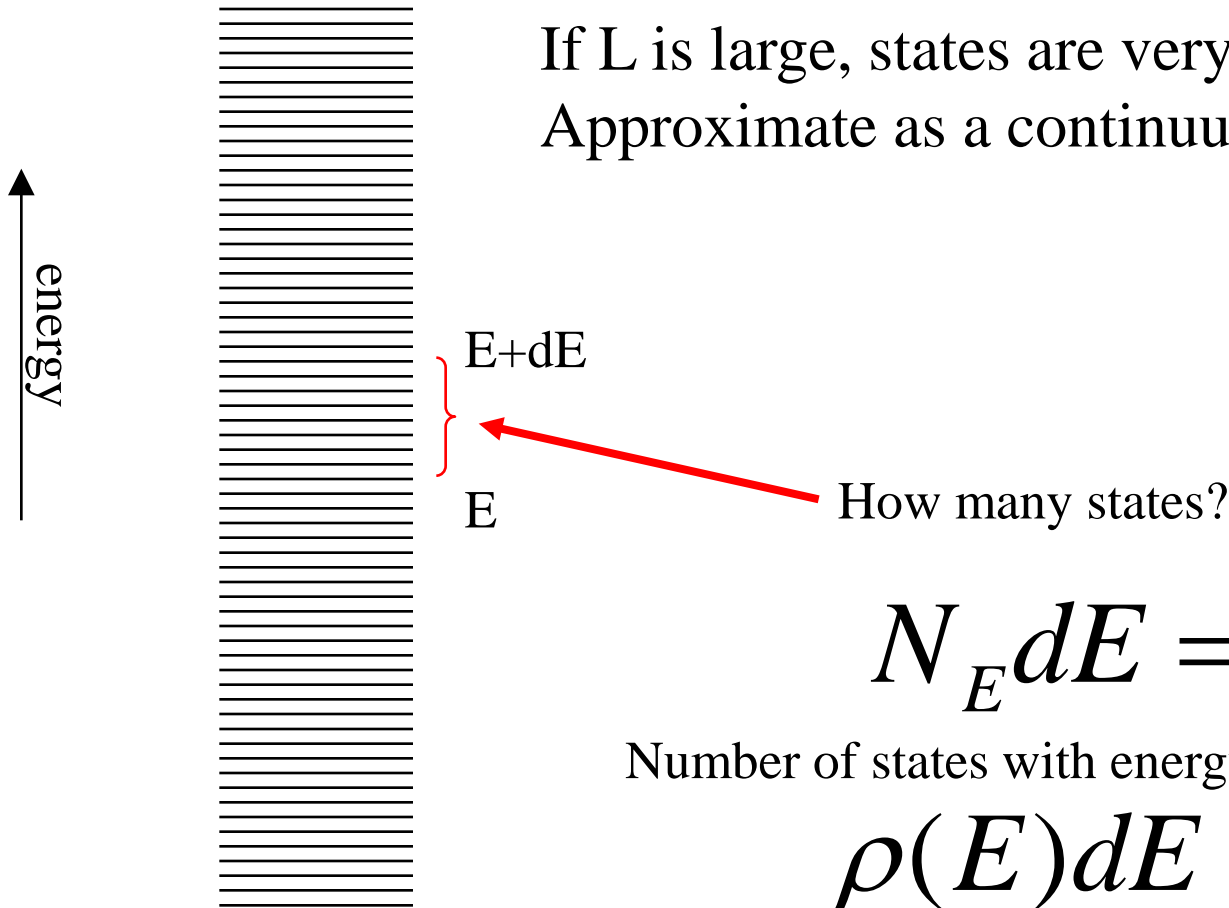

How many states?

$$N_E dE = ?$$

Number of states with energy between E and $E + dE$

$$\rho(E) dE = ?$$

Number of states with energy between E and $E + dE$ *per volume*

Density of states:

Easier first to think of in k-space:

Density of states in k-space is uniform:

One state per $(\pi/L)^3$:

Spread out in k_z direction (discuss).

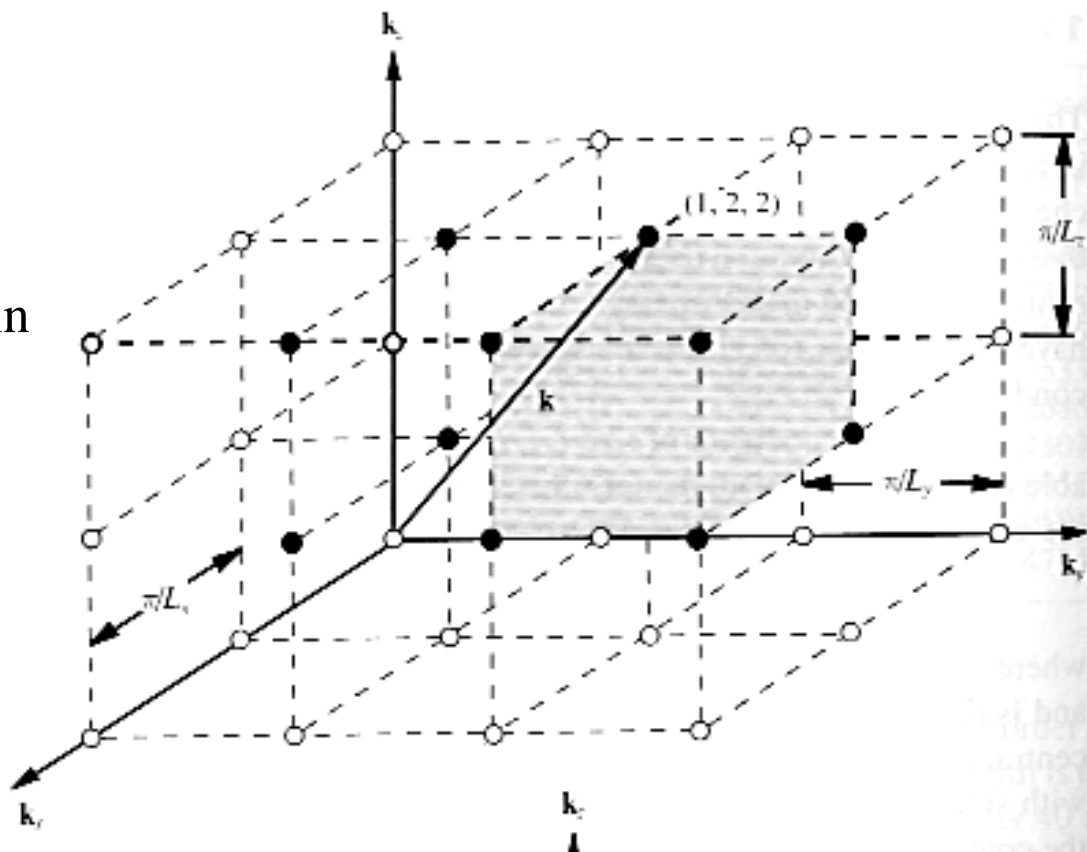

From Verdeyen

$$N_k dk = ?$$

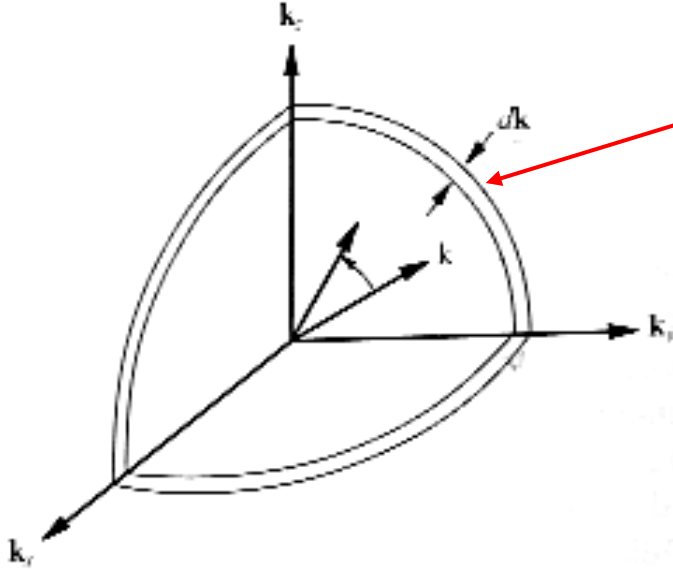

Volume of spherical shell
 $= 4\pi k^2 dk / 8$

8 is for upper right quadrant

Number of states in volume =
 Volume x States/volume

States/volume = $1 / (\pi/L)^3$:

$$N_k dk = \left(4\pi k^2 dk / 8 \right) \cdot \left(\frac{1}{(\pi/L)^3} \right) \cdot 2 = L^3 \frac{k^2 dk}{\pi^2}$$

$$\rho_k dk \equiv \frac{N_k dk}{\text{volume}} = \frac{k^2 dk}{\pi^2}$$

HW you will do calculation for 2 dimensional world.

$$N_k dk = ?$$

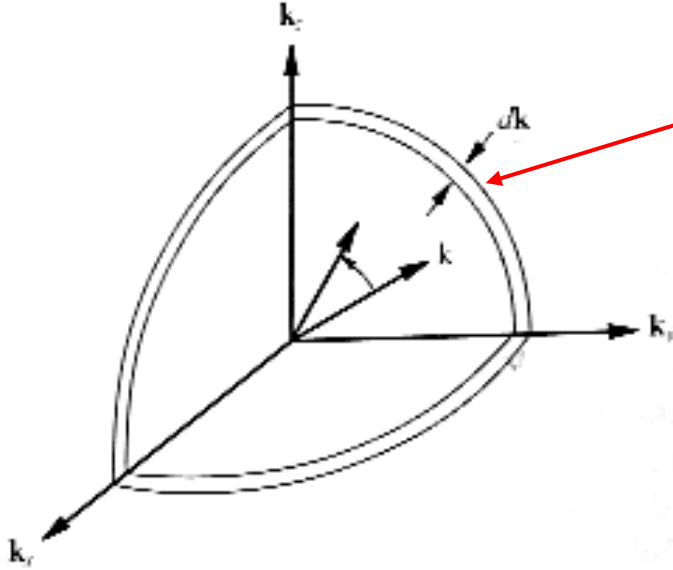

Volume of spherical ring
 $= 2\pi k dk / 4$

4 is for upper right quadrant

Number of states in volume =
 Volume x States/volume

States/volume = $1 / (\pi/L)^3$:

$$N_k dk = (2\pi k dk / 4) \cdot \left(\frac{1}{(\pi / L)^2} \right) \cdot 2 = L^2 \frac{k}{\pi} dk$$

$$\rho_k dk \equiv \frac{N_k dk}{\text{volume}} = \frac{k dk}{\pi}$$

HW you will do calculation for 2 dimensional world.

$$\rho(E)dE = ?$$

We use:

$$\rho_k dk = \rho(E)dE$$

$$\rho_k dk = \frac{k^2 dk}{\pi^2}$$

$$E = \frac{\hbar^2 k^2}{2m} \Rightarrow k = \sqrt{\frac{2mE}{\hbar^2}} \Rightarrow dk = \sqrt{\frac{2m}{\hbar^2}} \frac{dE}{2\sqrt{E}}$$

$$\rho(E)dE = \frac{2^{3/2} m^{3/2}}{\pi^2 \hbar^{3/2}} \cdot E^{1/2} dE$$

$$\rho(E)dE = ?$$

We use:

$$\rho_k dk = \rho(E)dE$$

$$\rho_k dk = \frac{k dk}{\pi}$$

$$E = \frac{\hbar^2 k^2}{2m} \Rightarrow k = \sqrt{\frac{2mE}{\hbar^2}} \Rightarrow dk = \sqrt{\frac{2m}{\hbar^2}} \frac{dE}{2\sqrt{E}}$$

$$\rho(E)dE = \frac{m}{\hbar\pi}$$

Fermi energy in 3 dimensions

$$\# \text{ electrons} = \int_0^{E_f} N_E dE = \int_0^{E_f} L^3 \frac{2^{1/2} m^{3/2}}{\pi^2 \hbar^{3/2}} \cdot E^{1/2} dE$$

$$\# \text{ electrons} = L^3 \frac{2^{1/2} m^{3/2}}{\pi^2 \hbar^{3/2}} \frac{2}{3} E_f^{3/2}$$

$$\Rightarrow E_f = \frac{\hbar^2 3^{2/3} \pi^{4/3}}{2m} \left(\frac{\# \text{ electrons}}{L^3} \right)^{2/3}$$

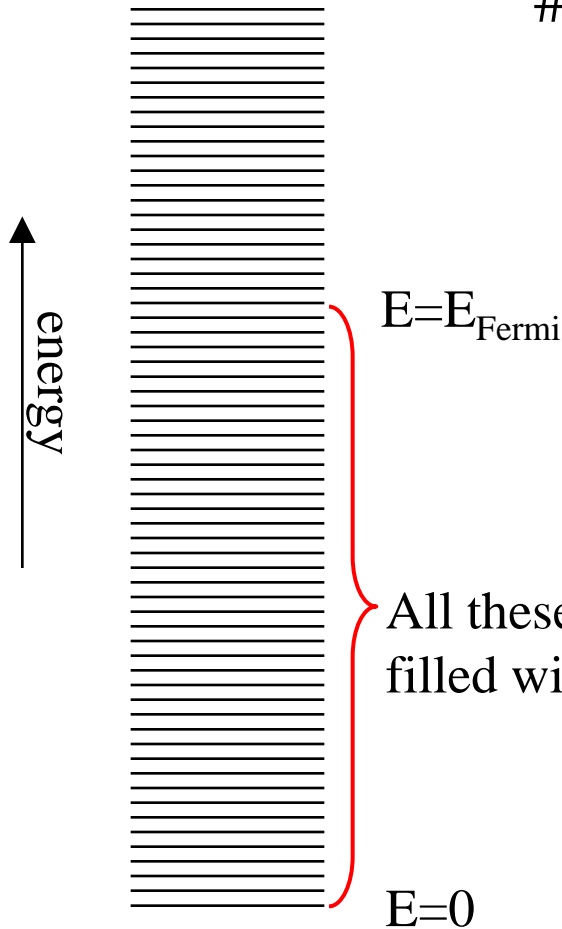

In a typical metal, $L \sim 0.1 \text{ nm}$.

$$E_f \sim 10 \text{ eV}$$

Fermi energy in 2 dimensions

$$\# \text{ electrons} = \int_0^{E_f} N_E dE = \int_0^{E_f} L^2 \frac{m}{\pi \hbar} dE$$

$$\# \text{ electrons} = L^2 \frac{m}{\pi \hbar} E_f$$

$$\Rightarrow E_f = \frac{\hbar \pi}{m} \left(\frac{\# \text{ electrons}}{L^2} \right)$$

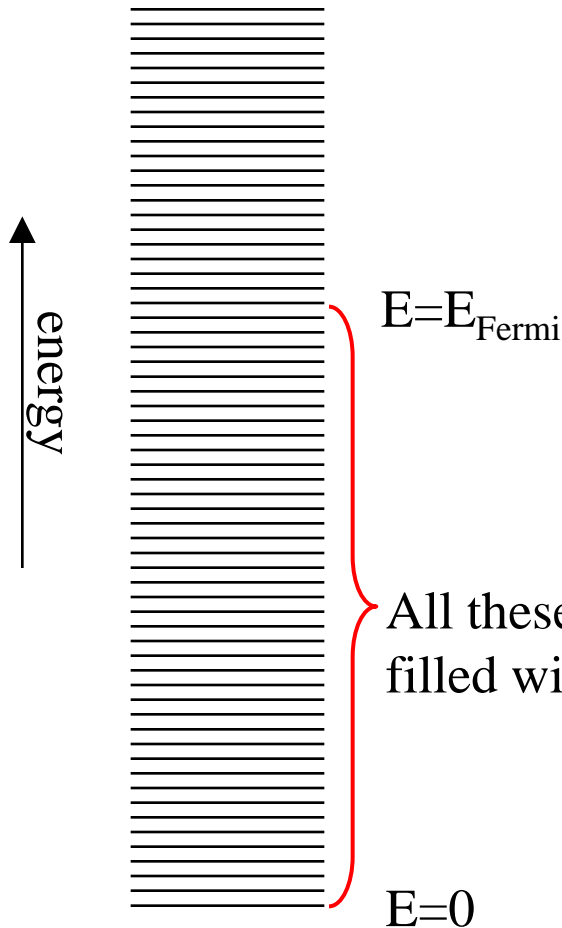

In GaAs, 10^{11}cm^{-2} gives

$$E_f \sim 1\text{-}10 \text{ meV}$$

But 10^{12}cm^{-2} gives more than first subband.

Discuss “subband”, how above integral gets modified.

Energy spectrum of free particles:

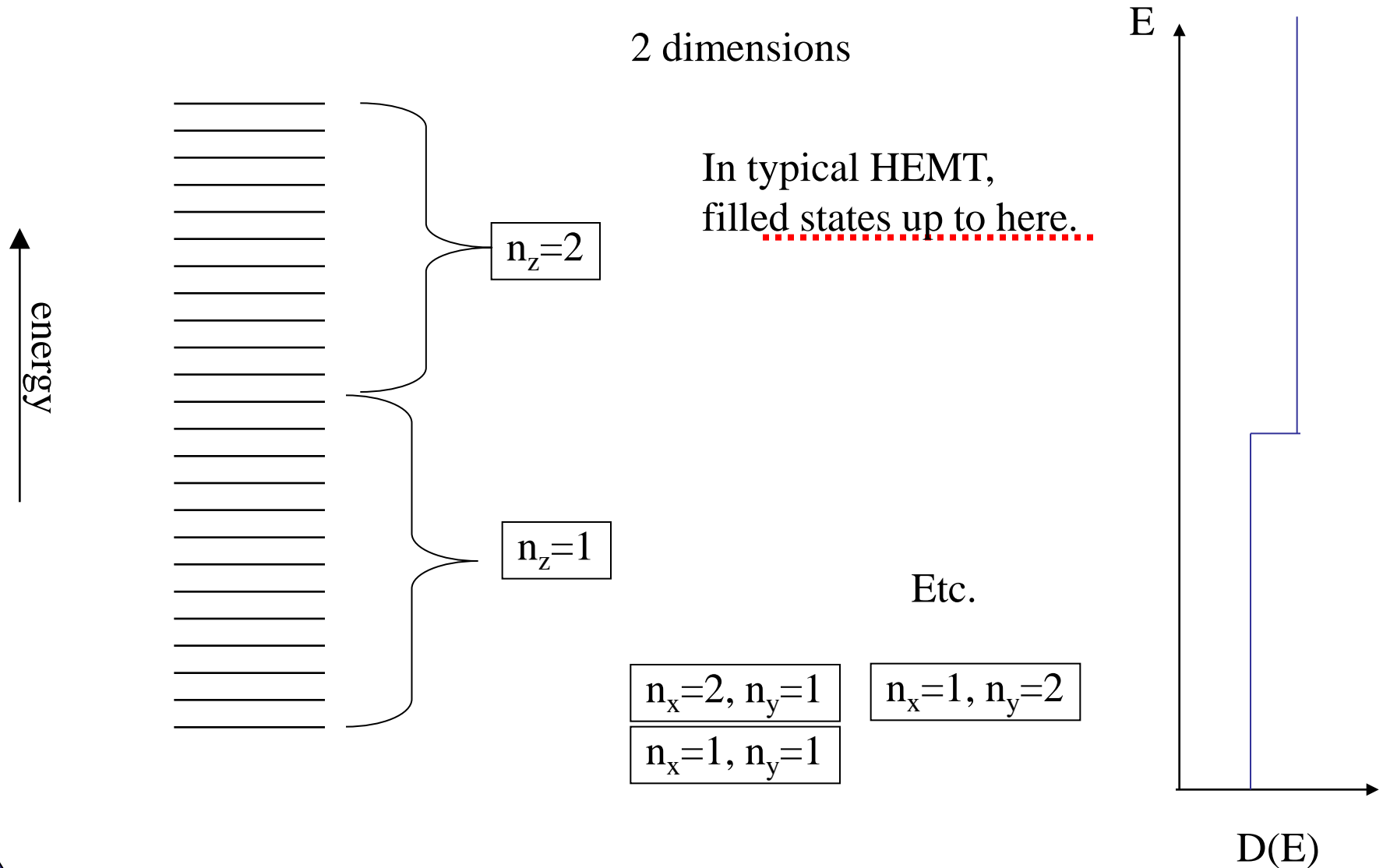

Triangle vs. square well:

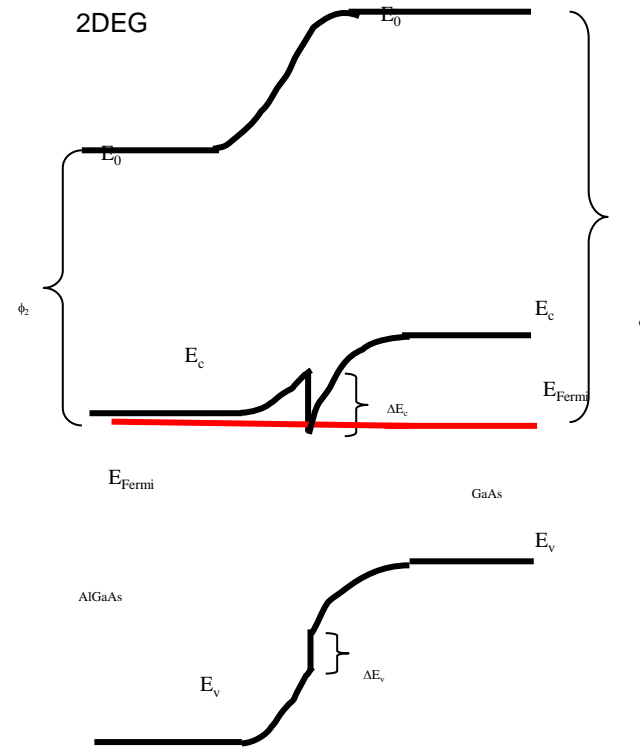
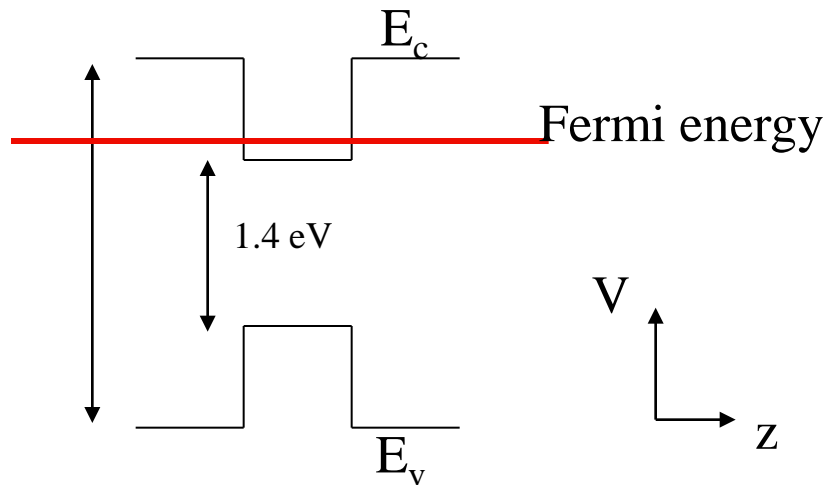

(Draw both bound states on board.
In particular discuss figure 5.21 from Liu.)
Also discuss shallow vs. wide wells on board.
(Typically 100 angstroms works.)

Fermi-Dirac:

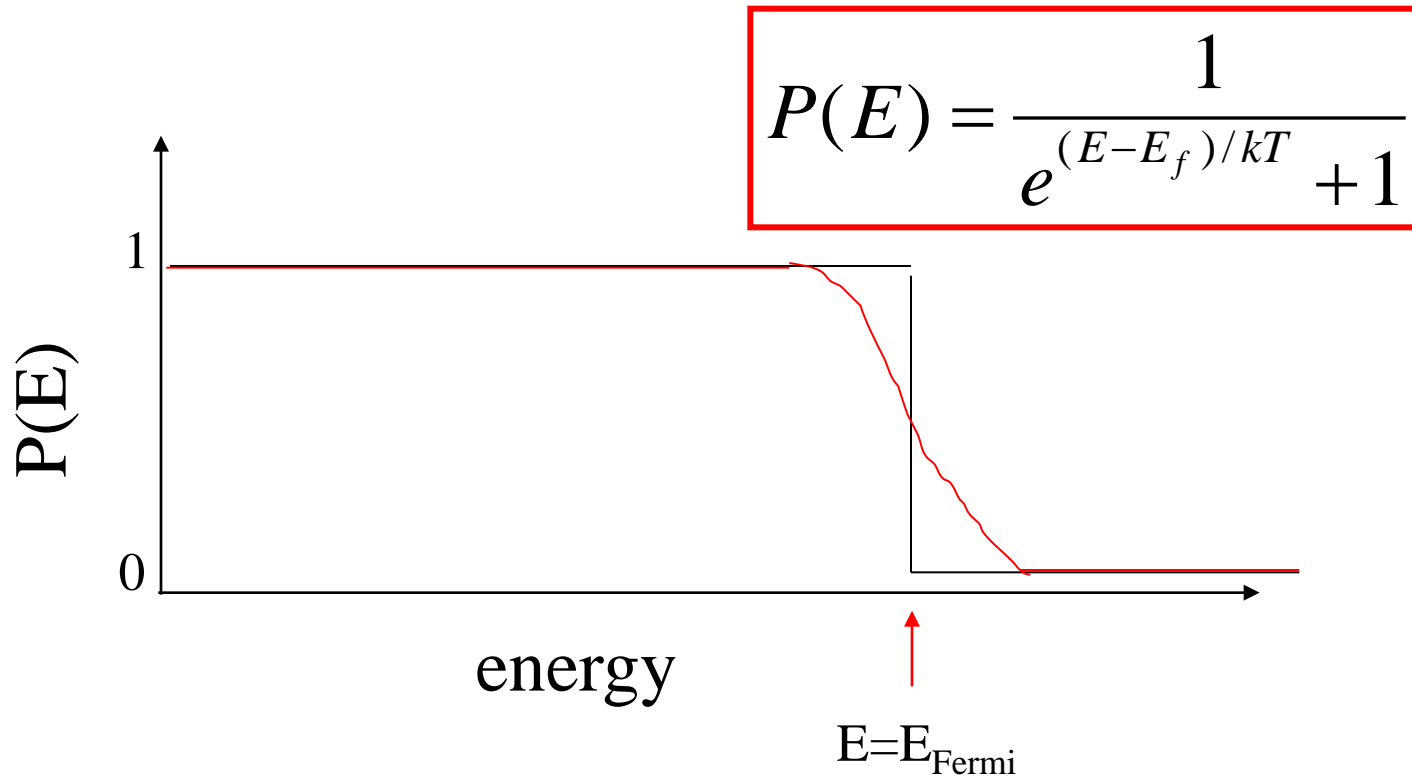

$P=1/2$ at E_f for all temperatures.

kT



Fermi energy in 2 dimensions

$$\# \text{ electrons} = \int_0^{E_f} N_E f(E) dE = ?$$

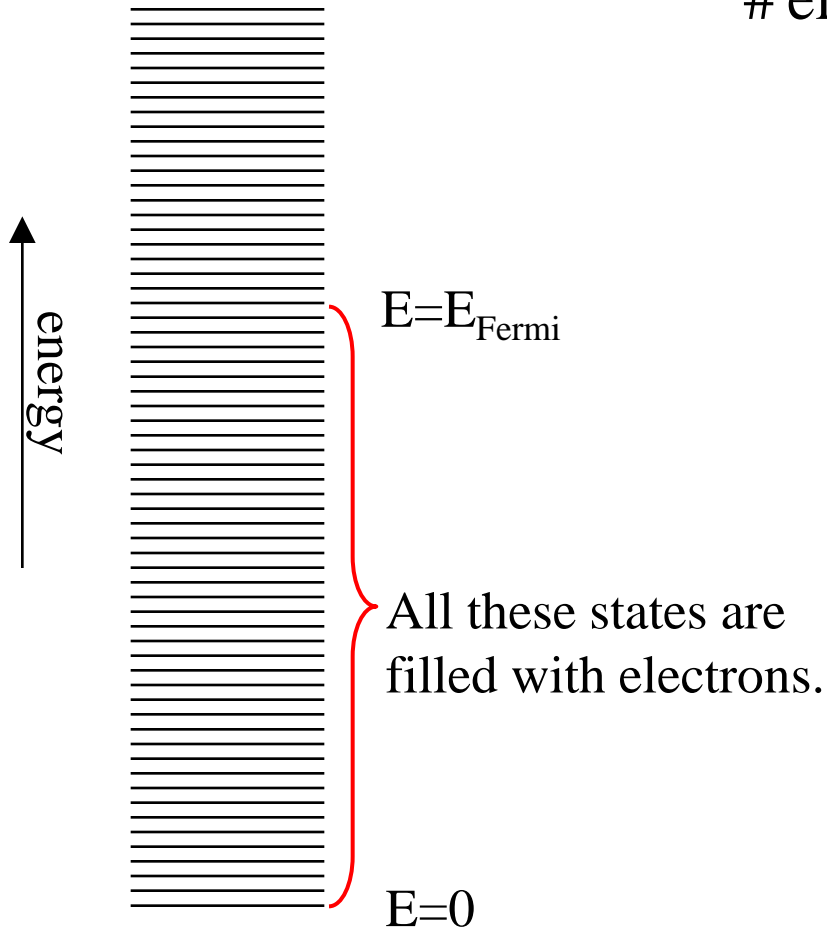

Need to evaluate integral numerically,
just as in 3d.

Problem

- Presence of electrons changes shape of potential well.
- We need a way to account for this.
- Will do in next lecture.