

Lectures 14: Graphene/Nanotubes

$R = ?$

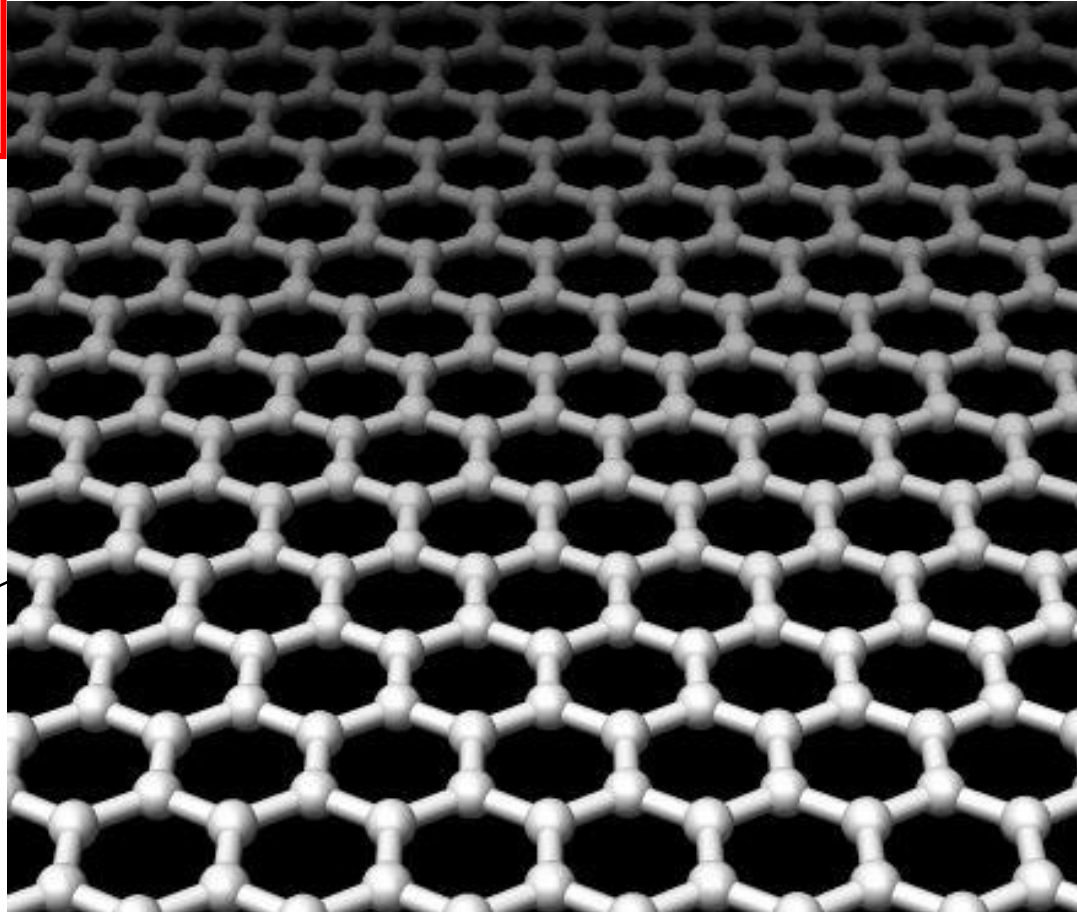

Allotropes of Carbon

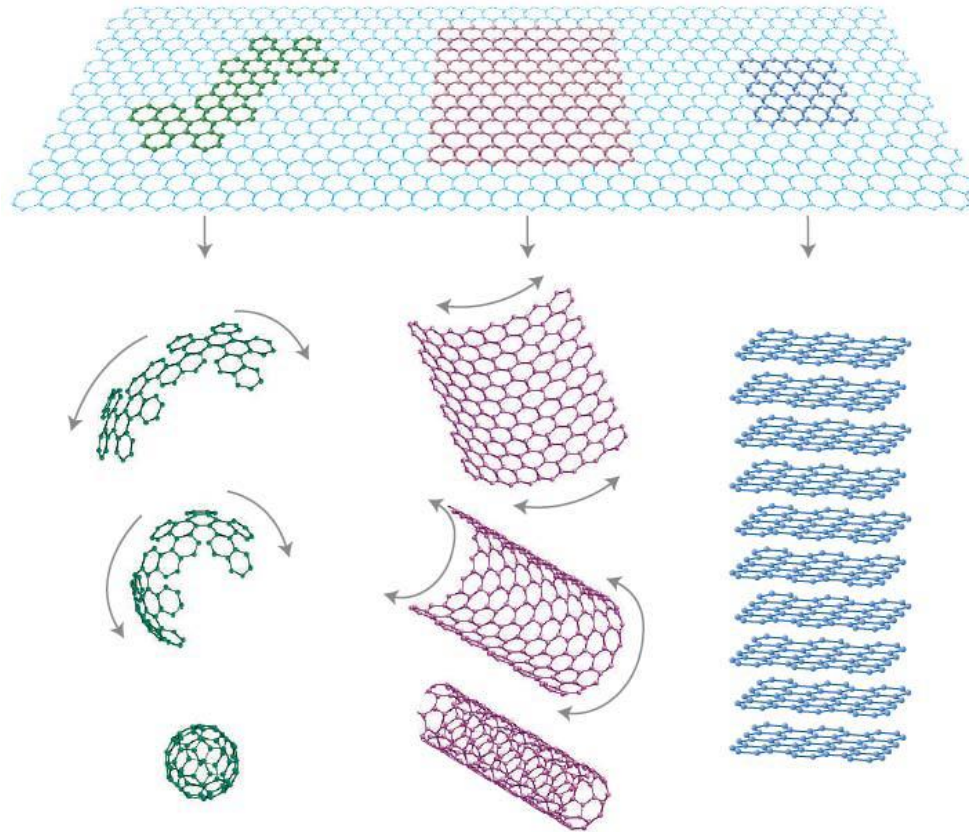

A. Geim and K. Novoselov, "The Rise of Graphene", *Nature Materials*, **6**, 183-191, (**2007**).

Silicon

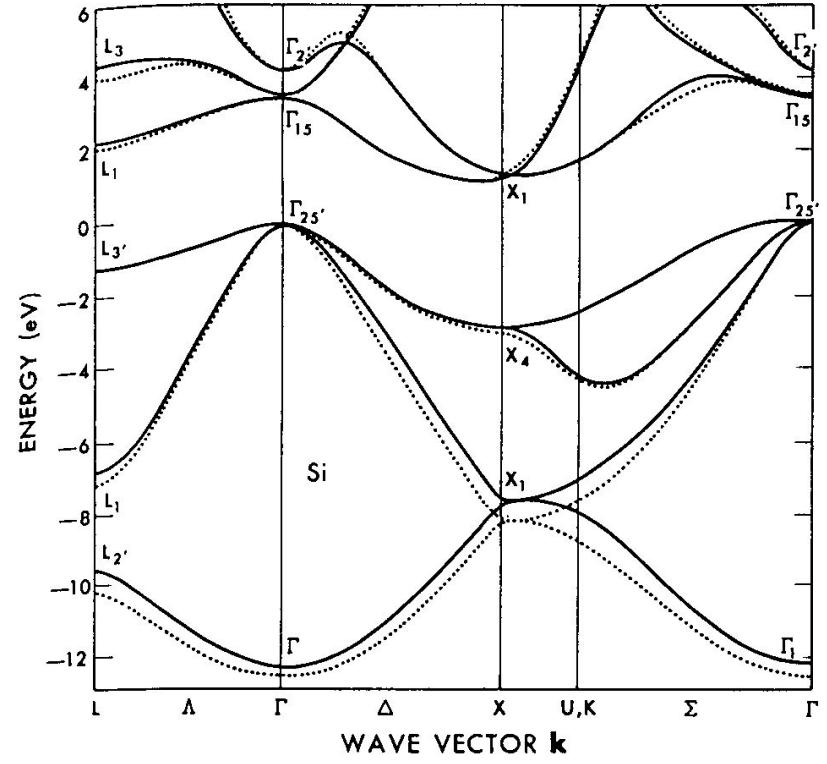
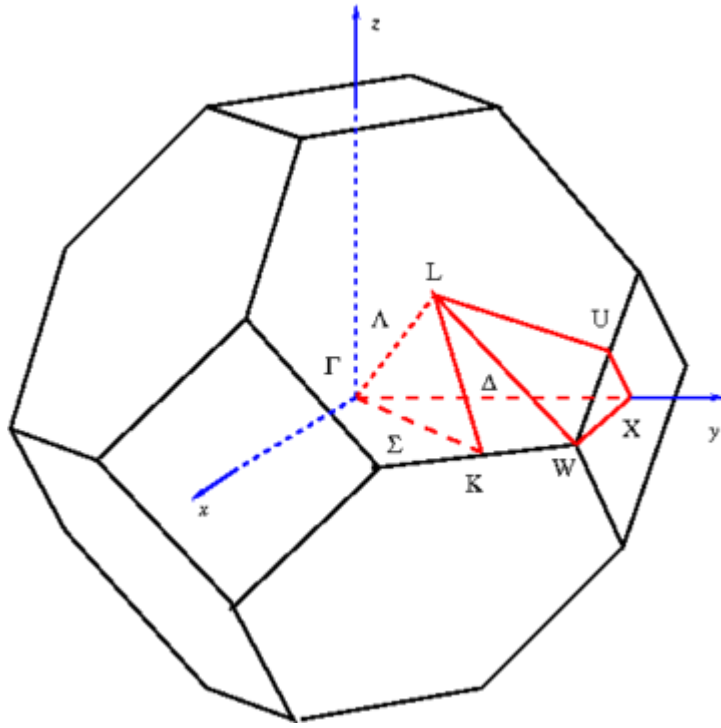

GaAs

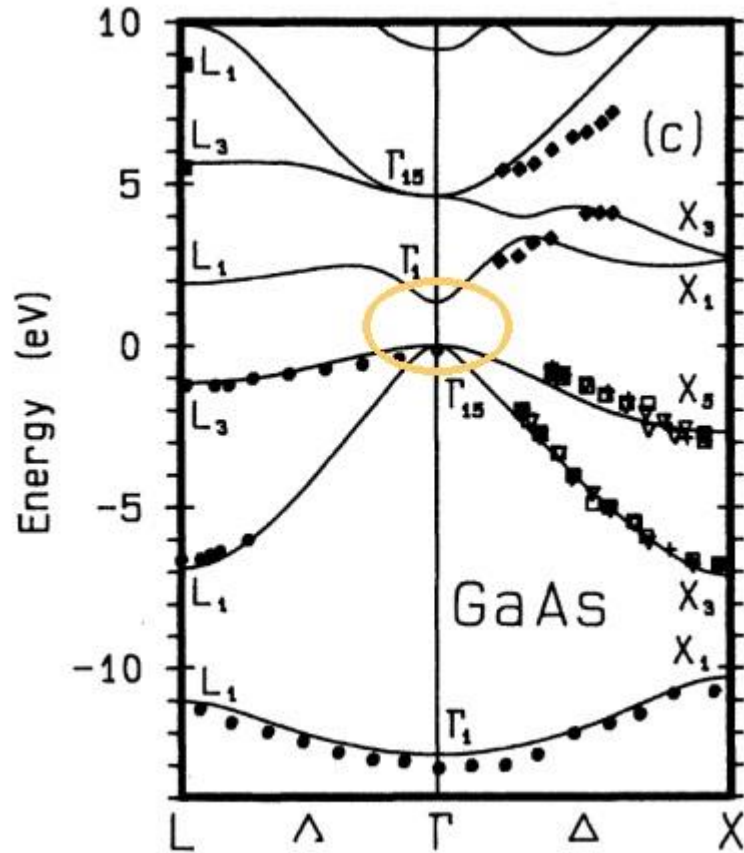

Graphene: 2d semiconductor

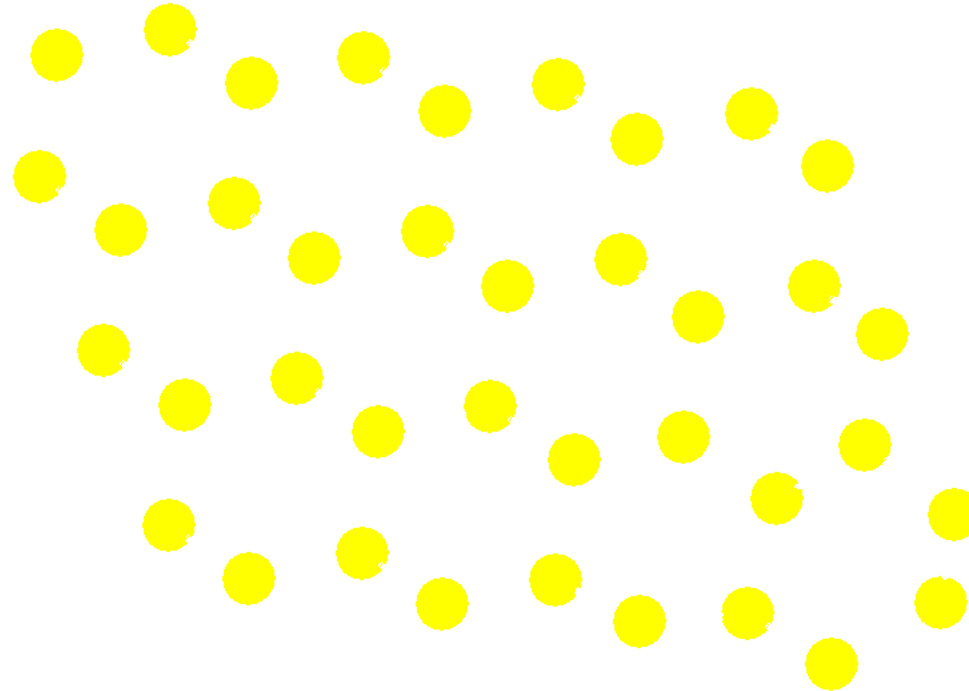

Bond length = 0.142 nm

Graphene band structure

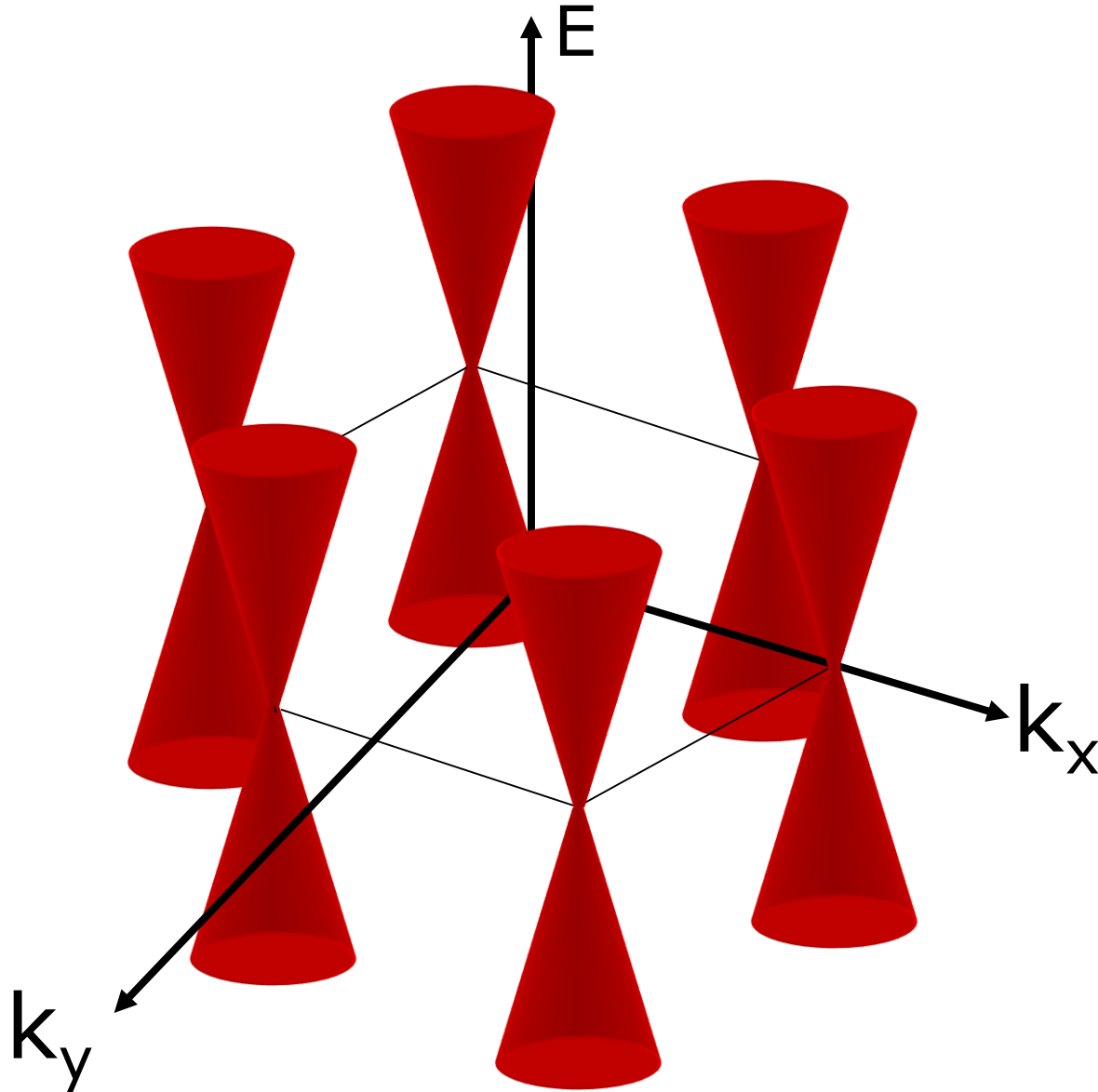

Synthesis

- Scotch tape
- SiC sublimation
- CVD

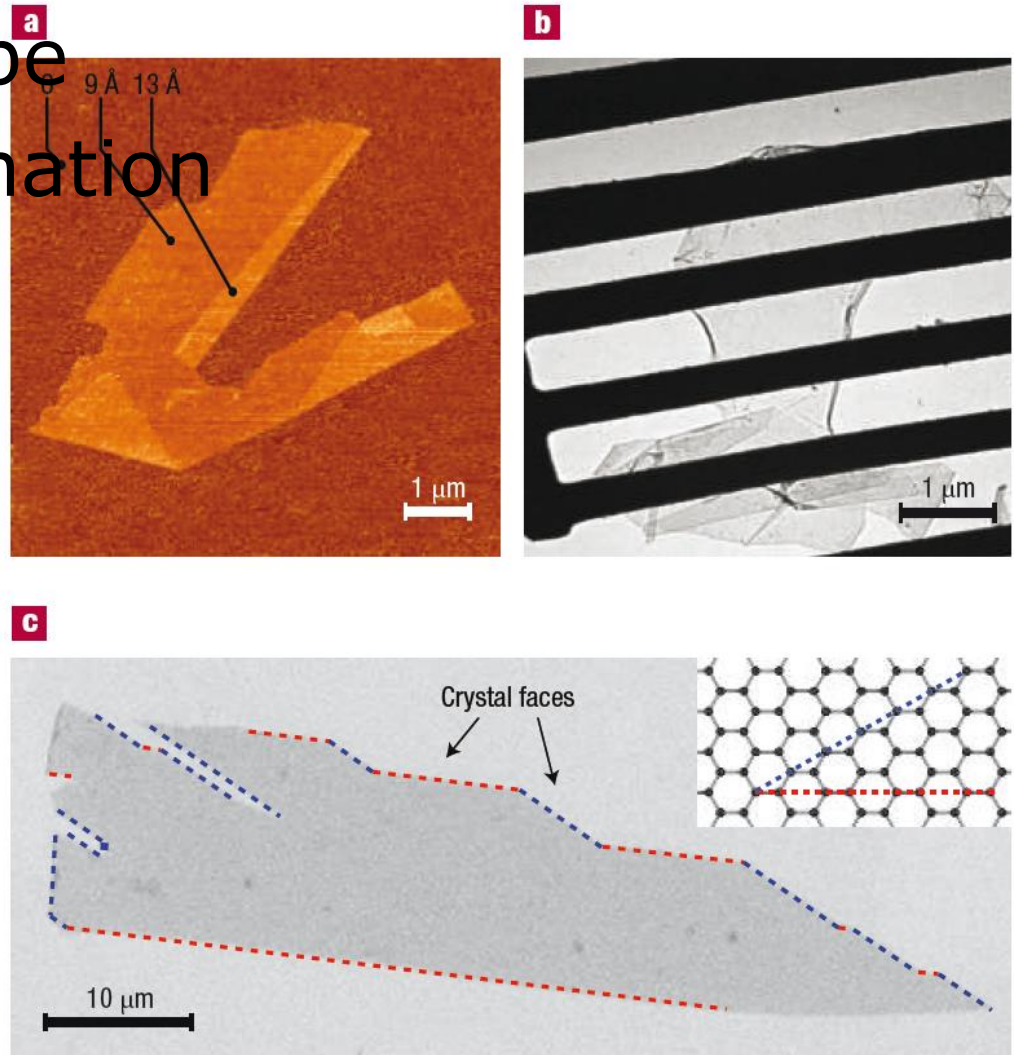

A. Geim and K. Novoselov, "The Rise of Graphene", *Nature Materials*, **6**, 183-191, (2007).

Characterization (DJ)

- Optical
- Raman

Transport (back gate)

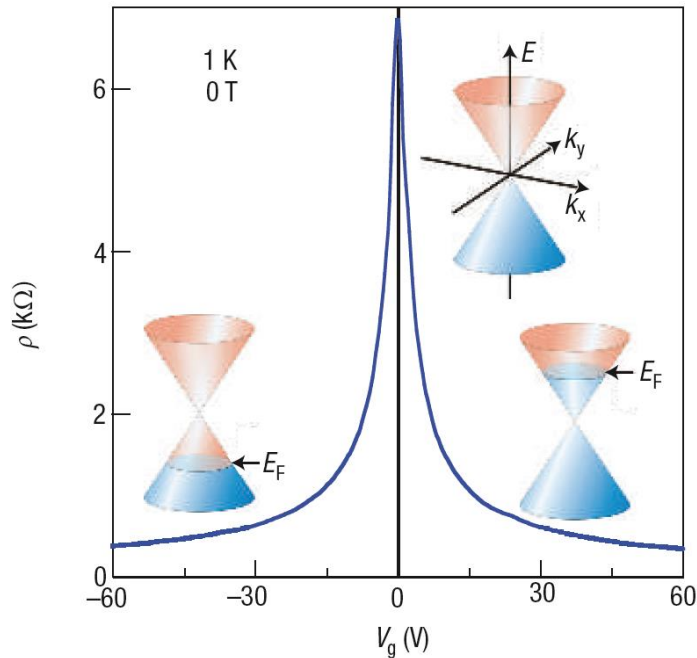

A. Geim and K. Novoselov, "The Rise of Graphene", *Nature Materials*, **6**, 183-191, (2007).

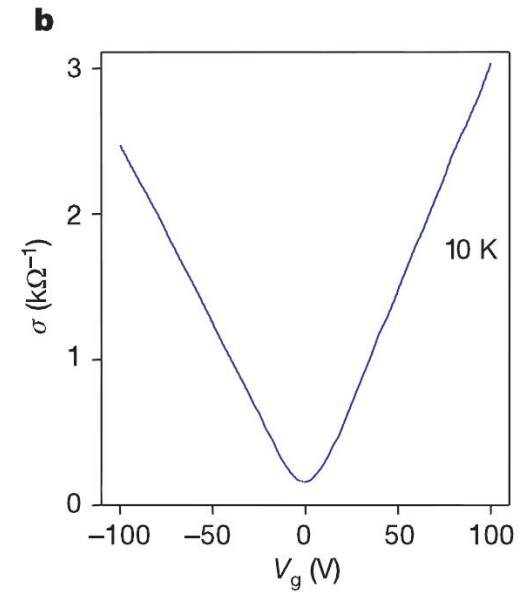

Novoselov, K., A. Geim, et al. (2005). "Two-dimensional gas of massless Dirac fermions in graphene." *Nature* **438**(7065): 197-200.

Graphene RF FET devices

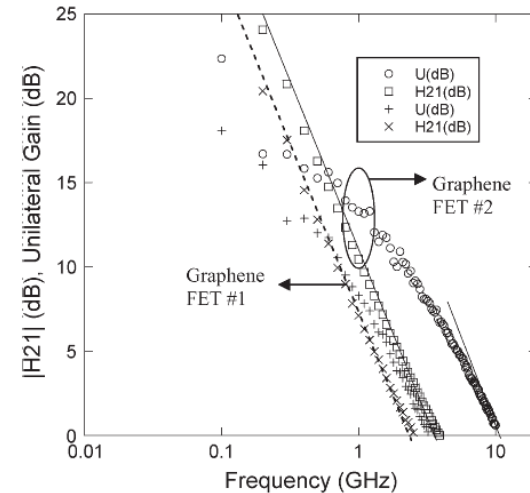
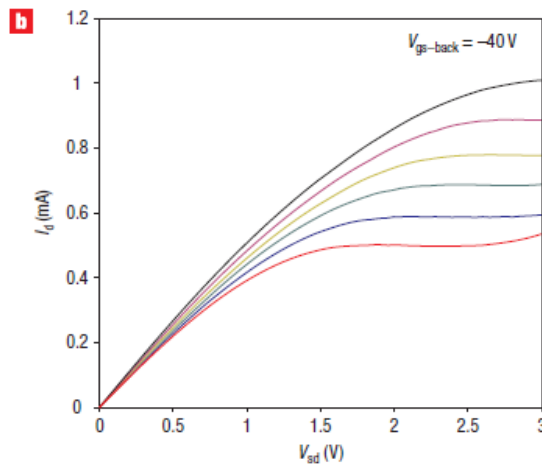
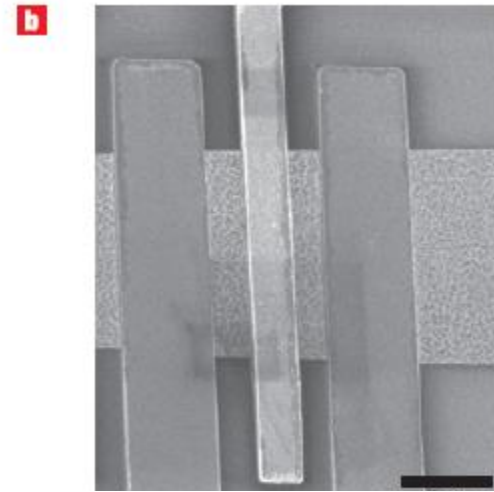
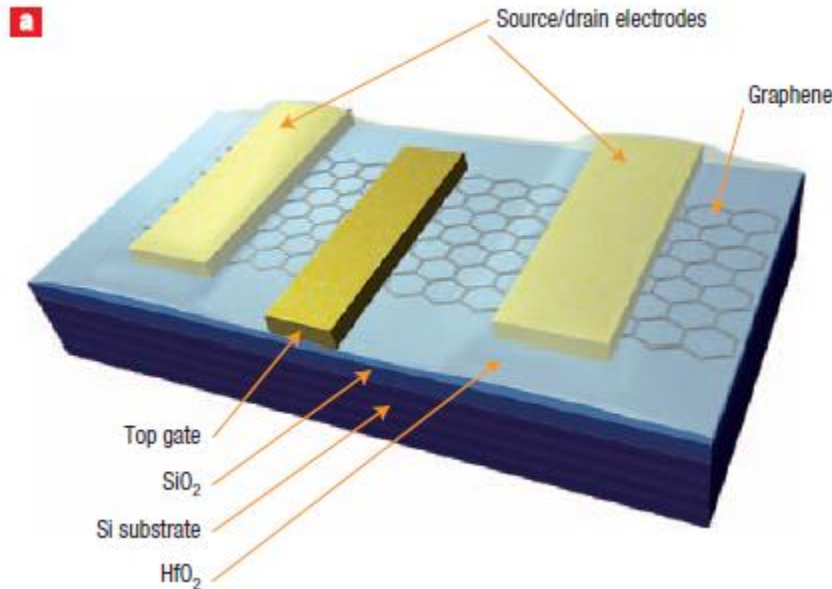

I. Meric, M. Han, A. Young, B. Ozyilmaz, P. Kim and K. Shepard, "Current Saturation in Zero-Bandgap, Top-Gated Graphene Field-Effect Transistors", *Nature Nanotechnology*, **3**, 654-659, (2008).

J. S. Moon, D. Curtis, M. Hu, D. Wong, C. McGuire, P. M. Campbell, G. Jernigan, J. L. Tedesco, B. VanMil, R. Myers-Ward, C. Eddy and D. K. Gaskill, "Epitaxial-Graphene Rf Field-Effect Transistors on Si-Face 6h-Sic Substrates", *Electron Device Letters, IEEE*, **30**, 650-652, (2009).

Cutoff frequency

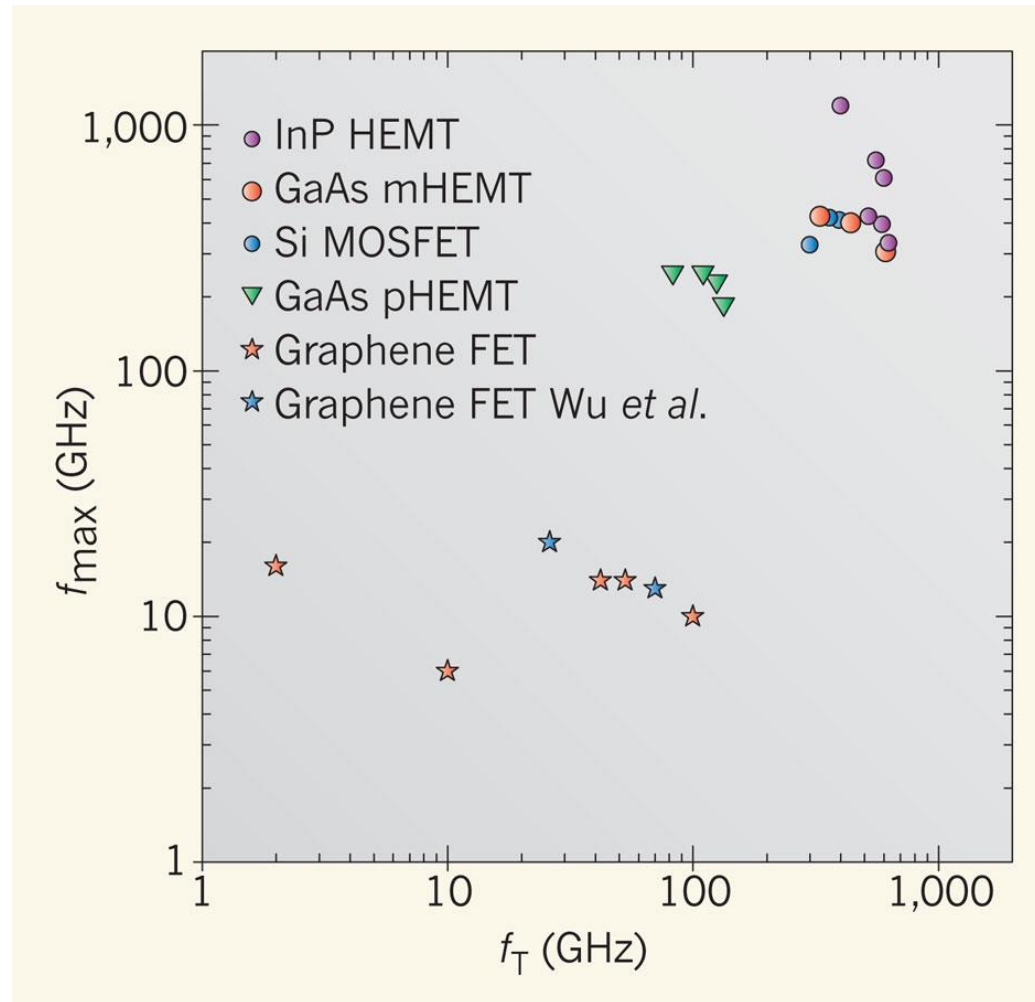

Schwierz, F. (2011). "Electronics: Industry-compatible graphene transistors." Nature **472**(7341): 41-42.

Graphene optical properties

$$T_{\text{opt}} = \left(1 + \frac{\pi\alpha}{2}\right)^{-2} \approx 1 - \pi\alpha \approx 0.977$$

Nair, R. R., P. Blake, et al. (2008). "Fine Structure Constant Defines Visual Transparency of Graphene." Science **320**(5881): 1308.

Spectrum of absorption

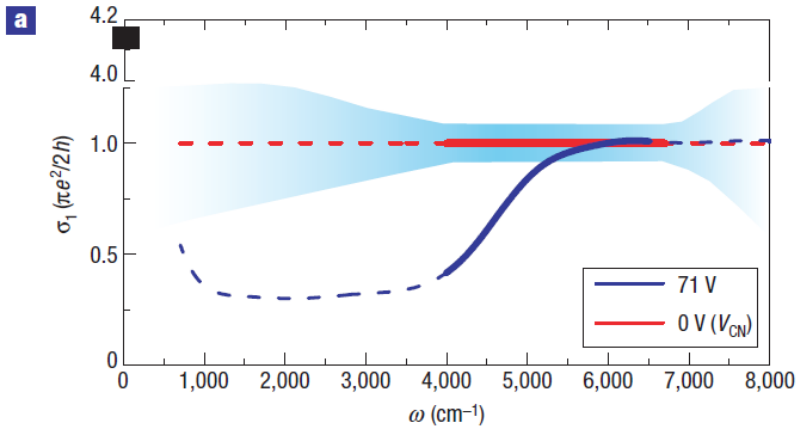

$$\text{Re } \sigma_{xx}(\Omega) = \frac{e^2}{h} |\mu| \frac{4\Gamma}{\Omega^2 + 4\Gamma^2} + \frac{\pi e^2}{2h} \theta(\Omega - 2|\mu|).$$

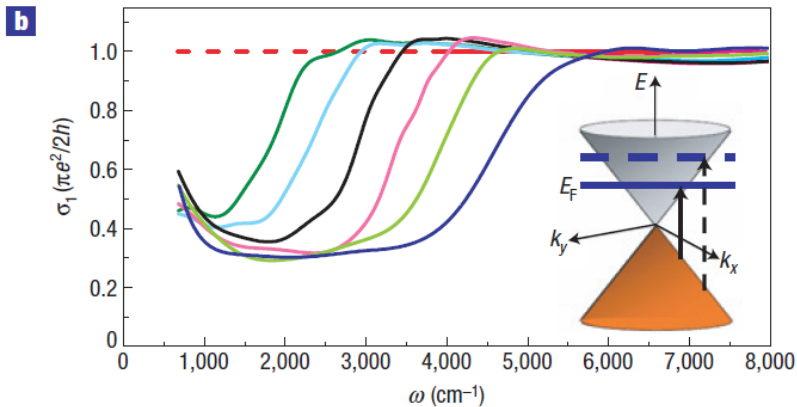

Li, Z., E. Henriksen, et al. (2008). "Dirac charge dynamics in graphene by infrared spectroscopy." *Nature Physics* **4**(7): 532-535.

Gusynin, V., S. Sharapov, et al. (2009). "On the universal ac optical background in graphene." *New Journal of Physics* **11**: 095013.

Lectures 14: Carbon Nanotubes

$$R = ?$$

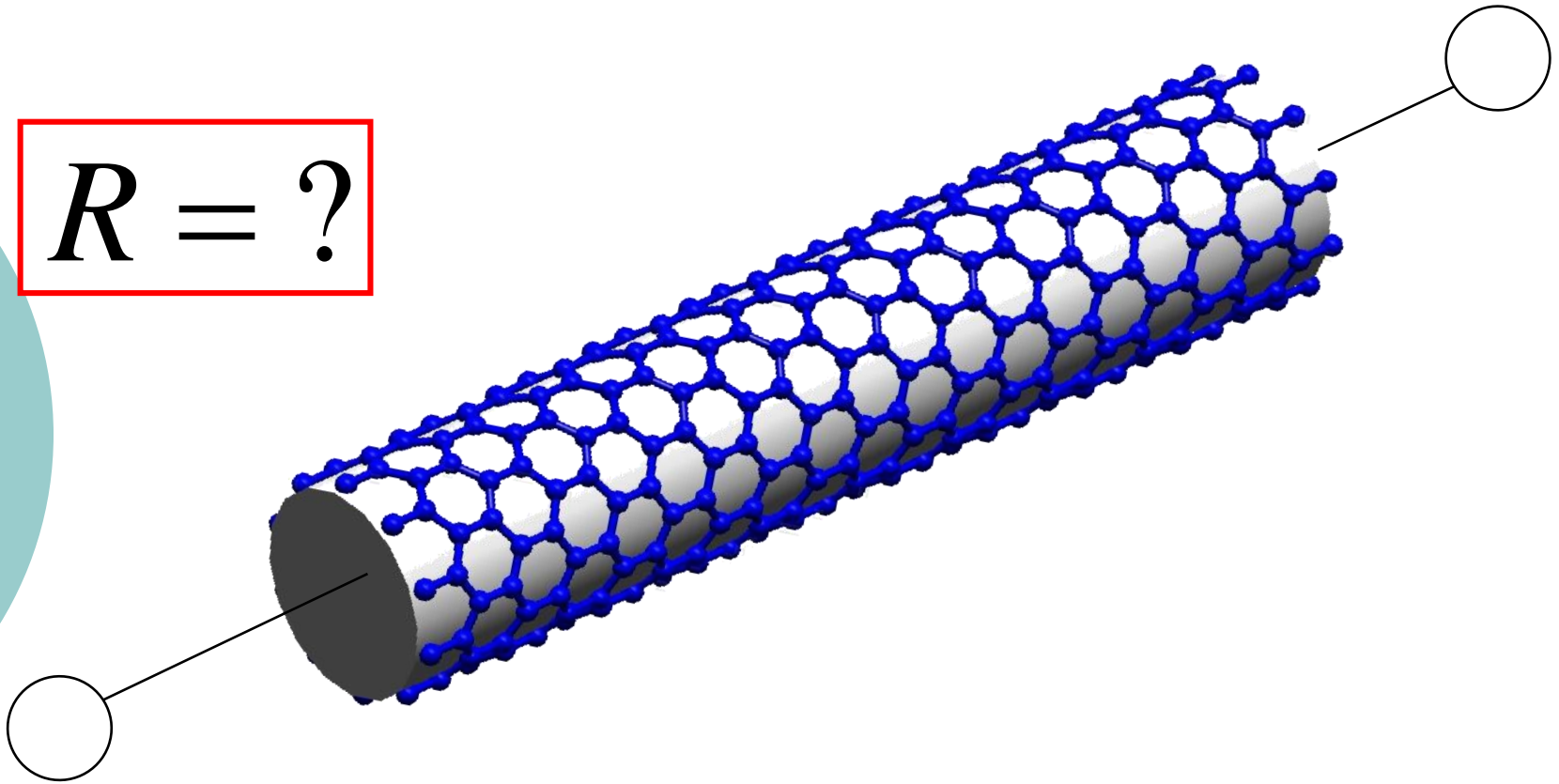

Readings this lecture covers

- Hanson, pp. 170-176
- McEuen review, *IEEE Transactions on Nanotechnology*, reading packet

Nanotube: Zig-zag vs. armchair

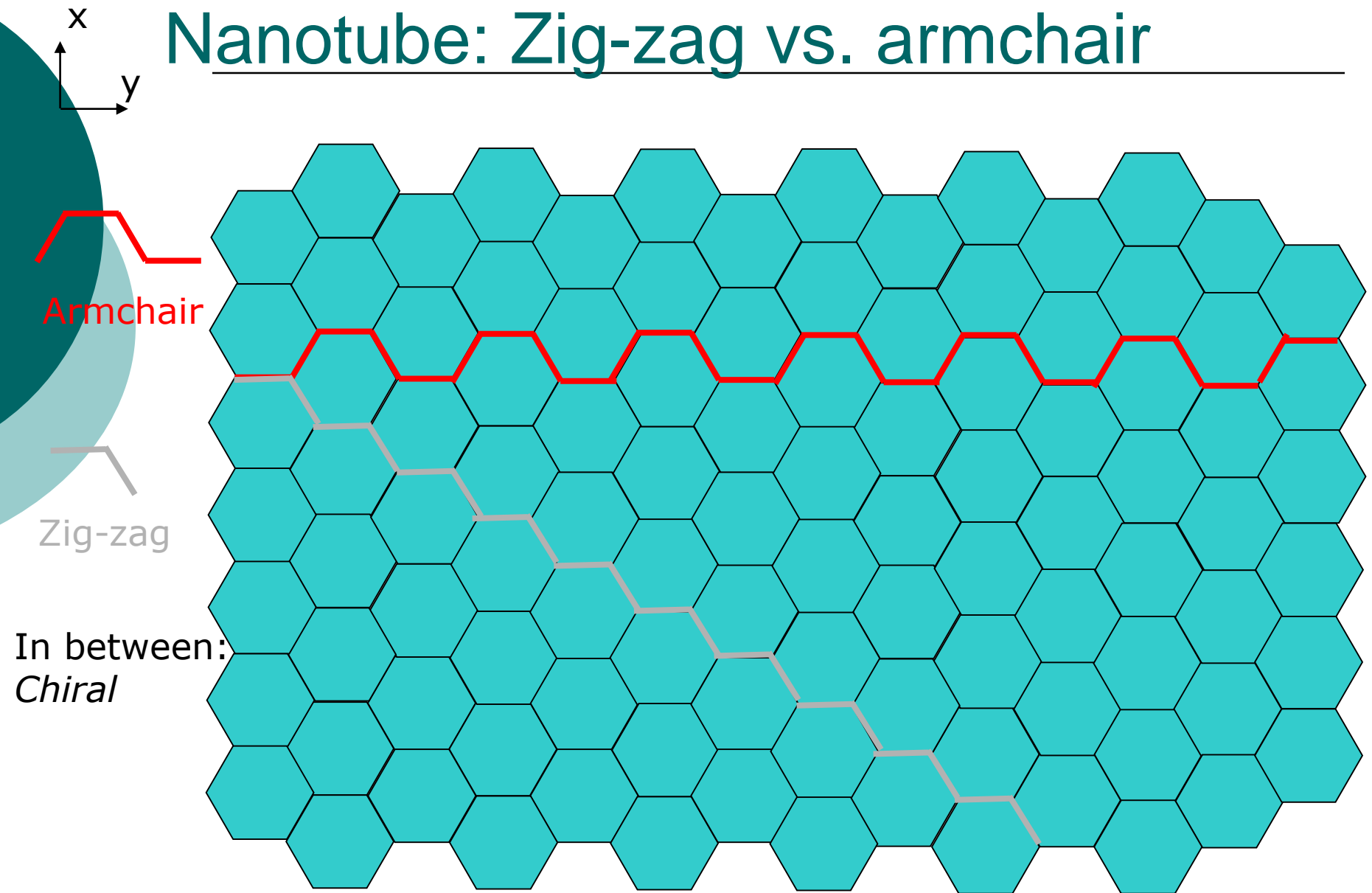

Nanotube: (n,m) description

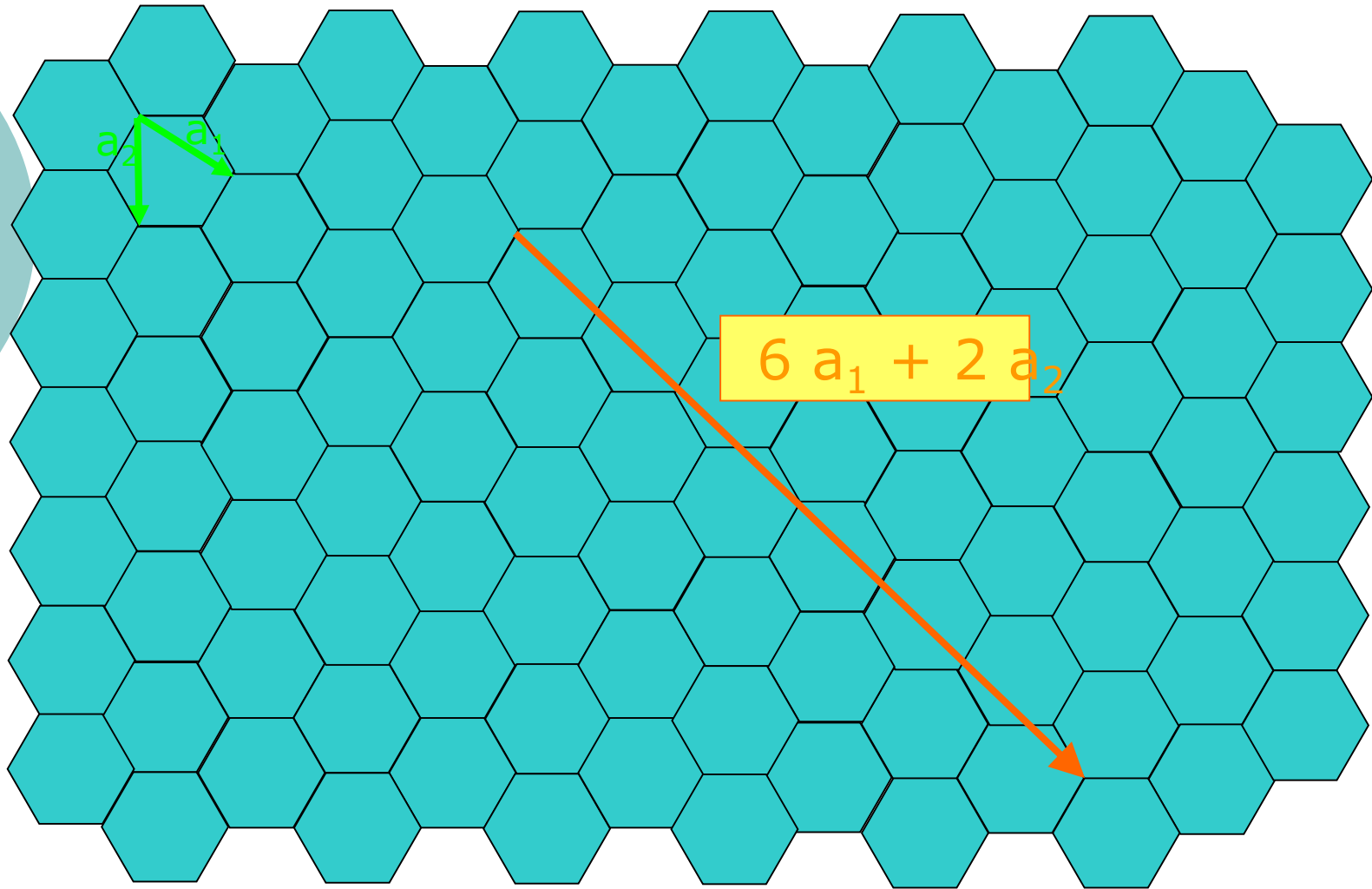

In this example: $(n,m) = (6,2)$

k-vector

- Graphite:
 - Arbitrary k_x, k_y allowed
- Nanotube:
 - $\psi(\phi) = \psi(\phi + 2\pi)$
 - k_{perp} spaced by $2/d$

Allowed k-vectors:

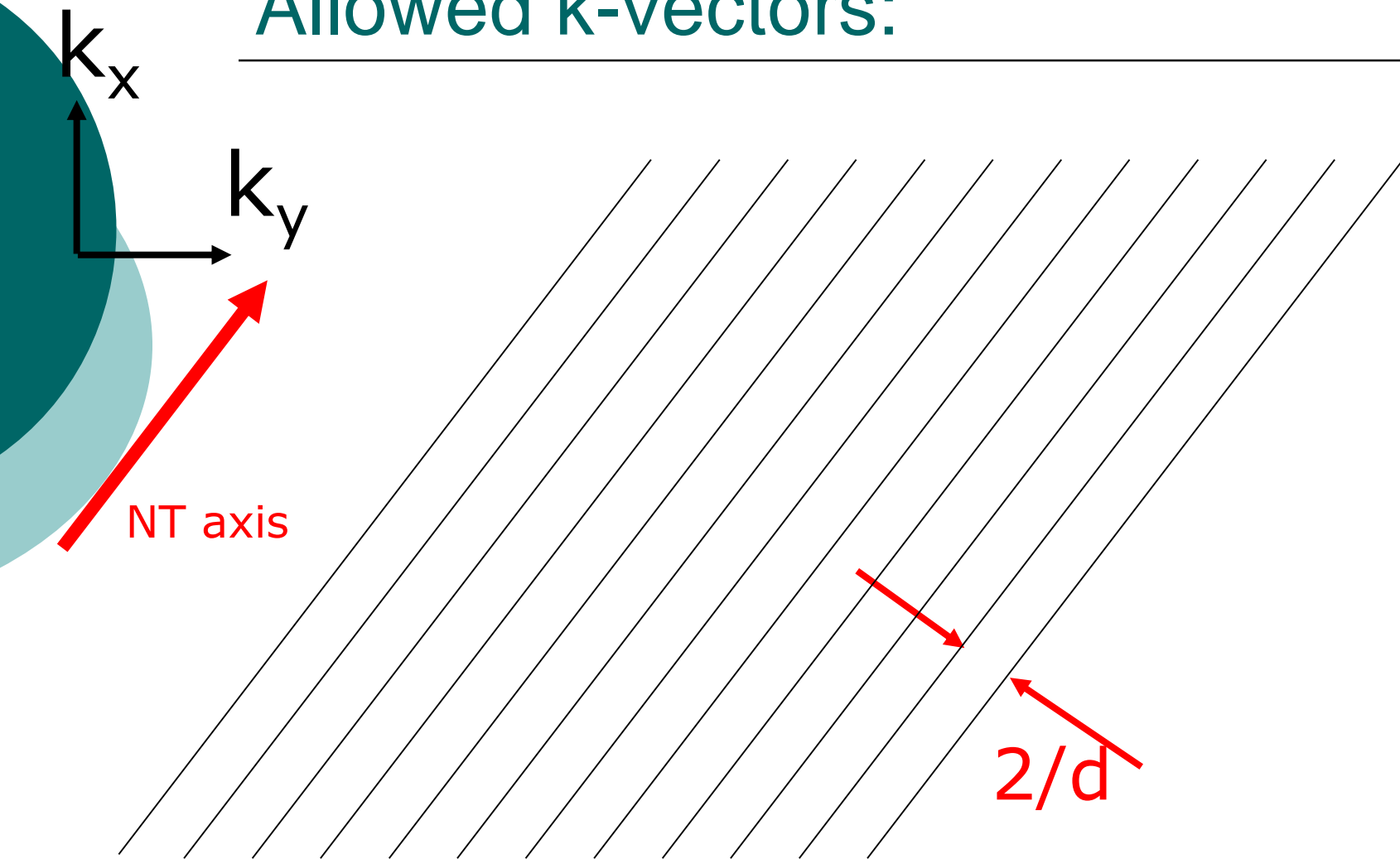

k-space

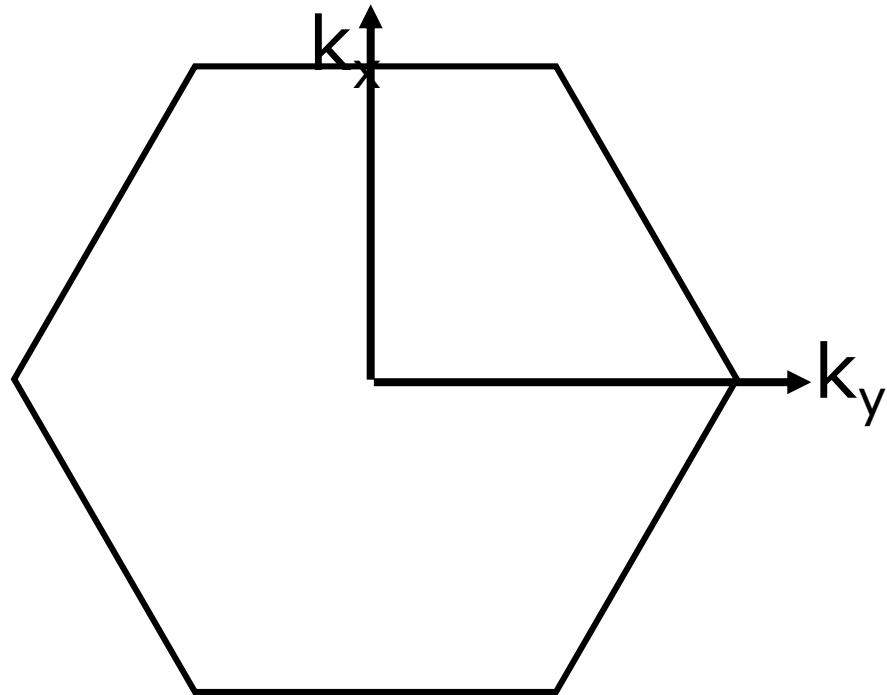

(9,0) armchair nanotube

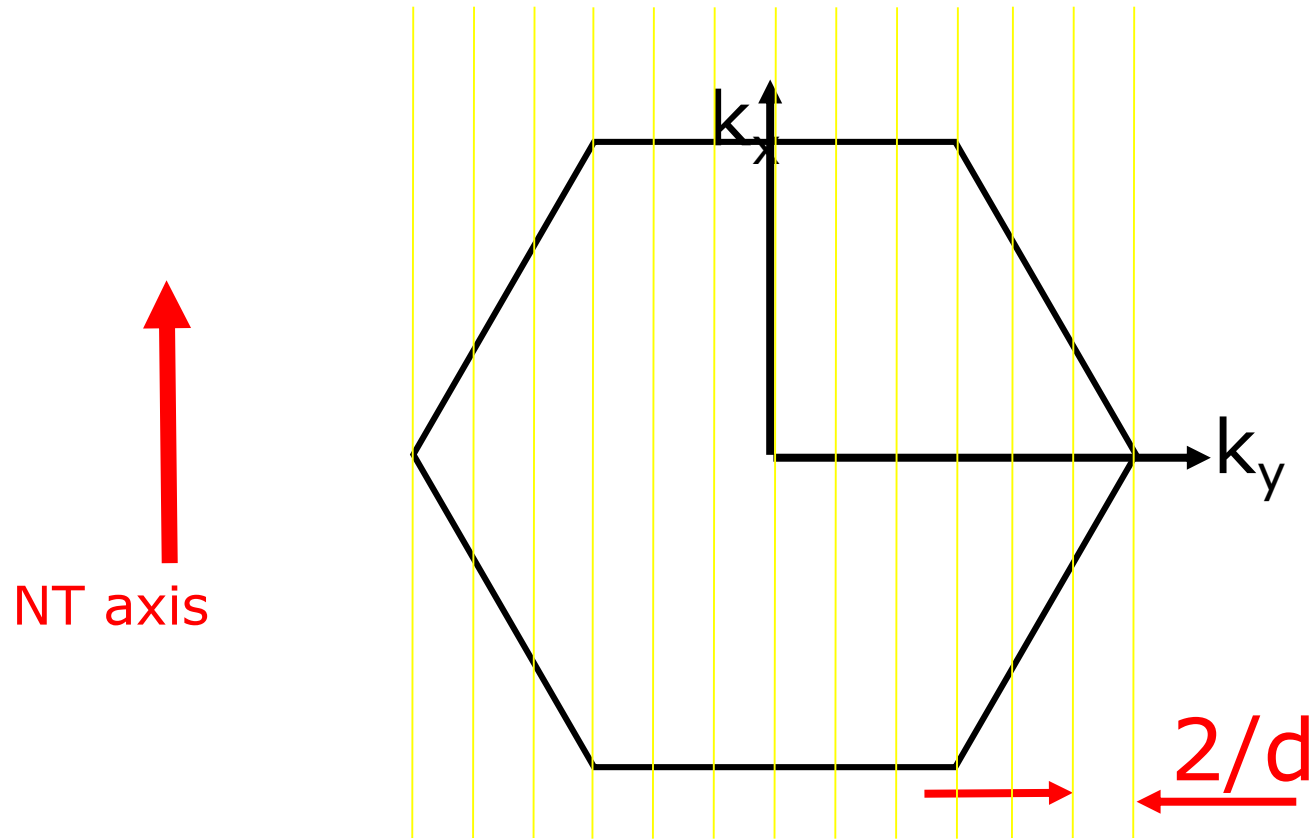

All armchairs are metallic. $G = \frac{2e^2}{h} \sum T_n = \frac{4e^2}{h}$

Semiconducting nanotube

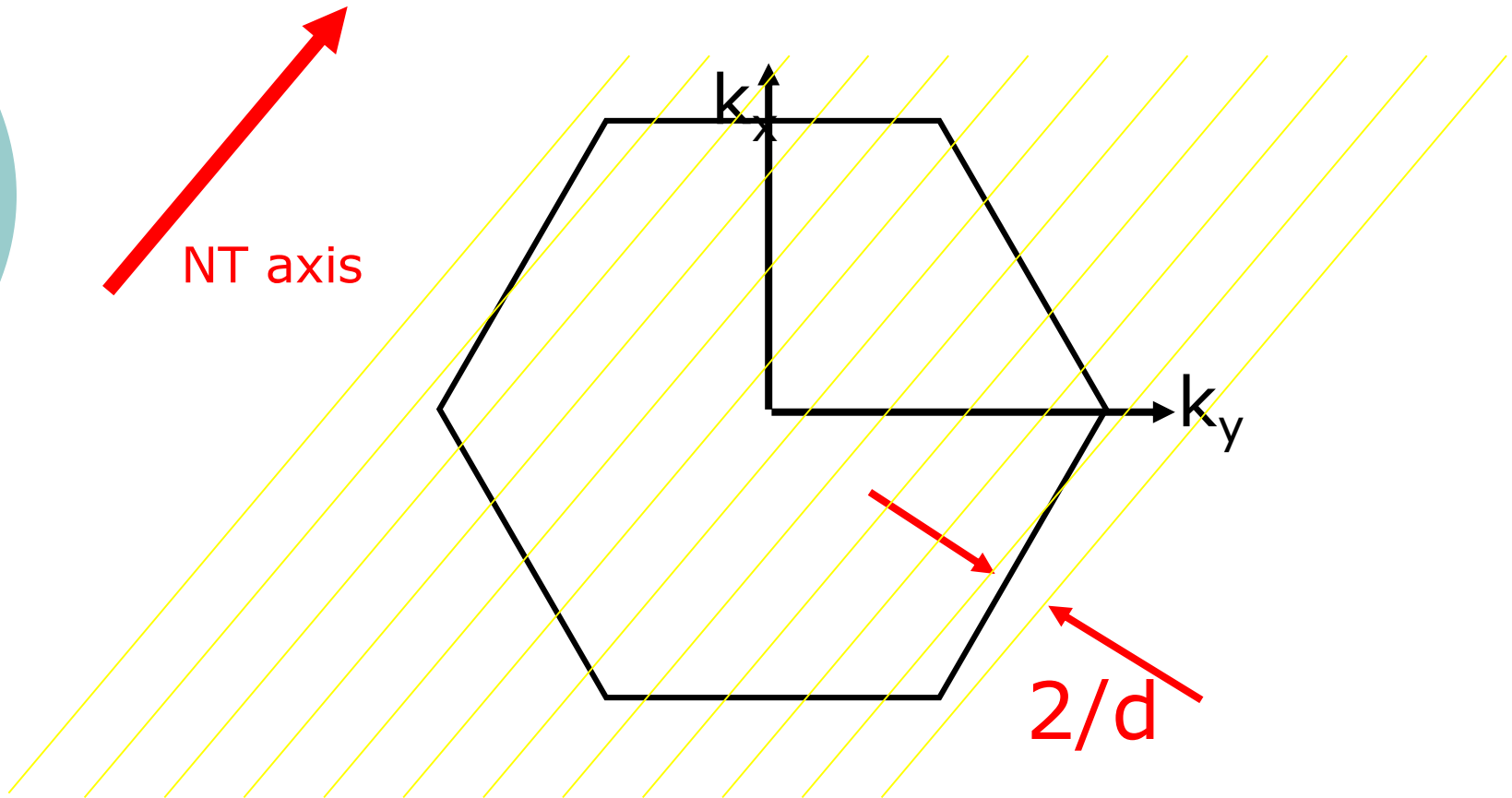

Electrical properties

- All armchair metallic
- 33% of zig-zag metallic
- Semiconducting tubes:
 - Gap = $0.9 \text{ eV}/d[\text{nm}]$

Multi-walled nanotube (MWNT)

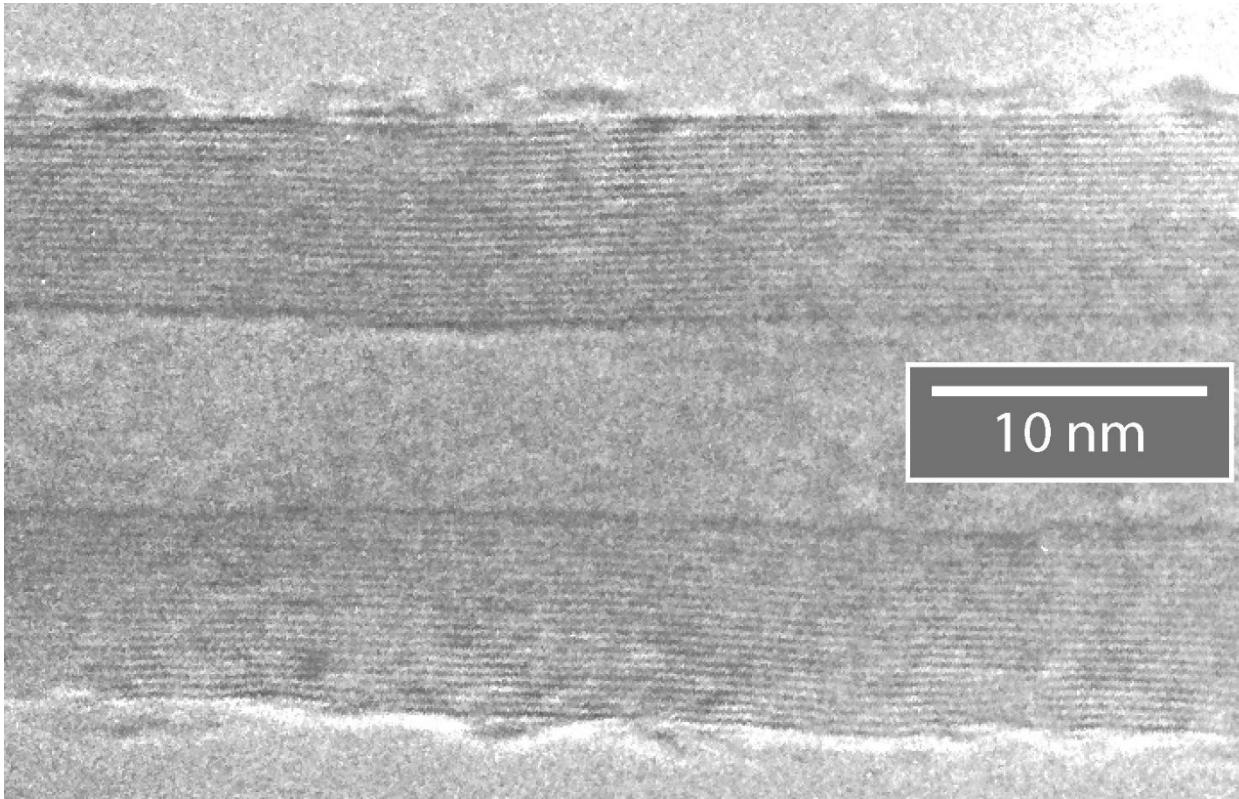

Shengdong Li, unpublished

Growth technologies

- Arc discharge
- Laser ablation
- Chemical vapor deposition (CVD)

CVD

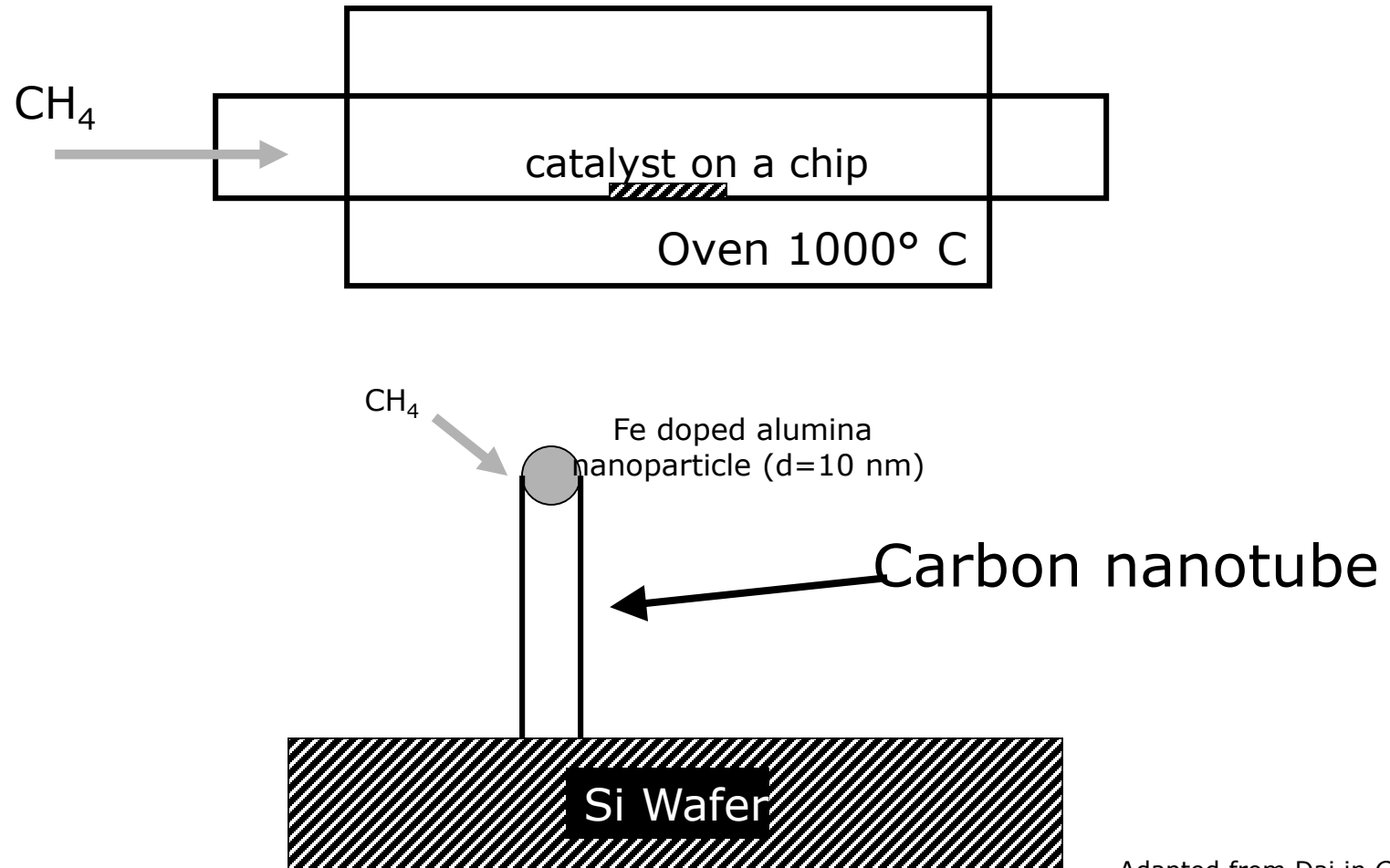

Lithographically defined catalysts

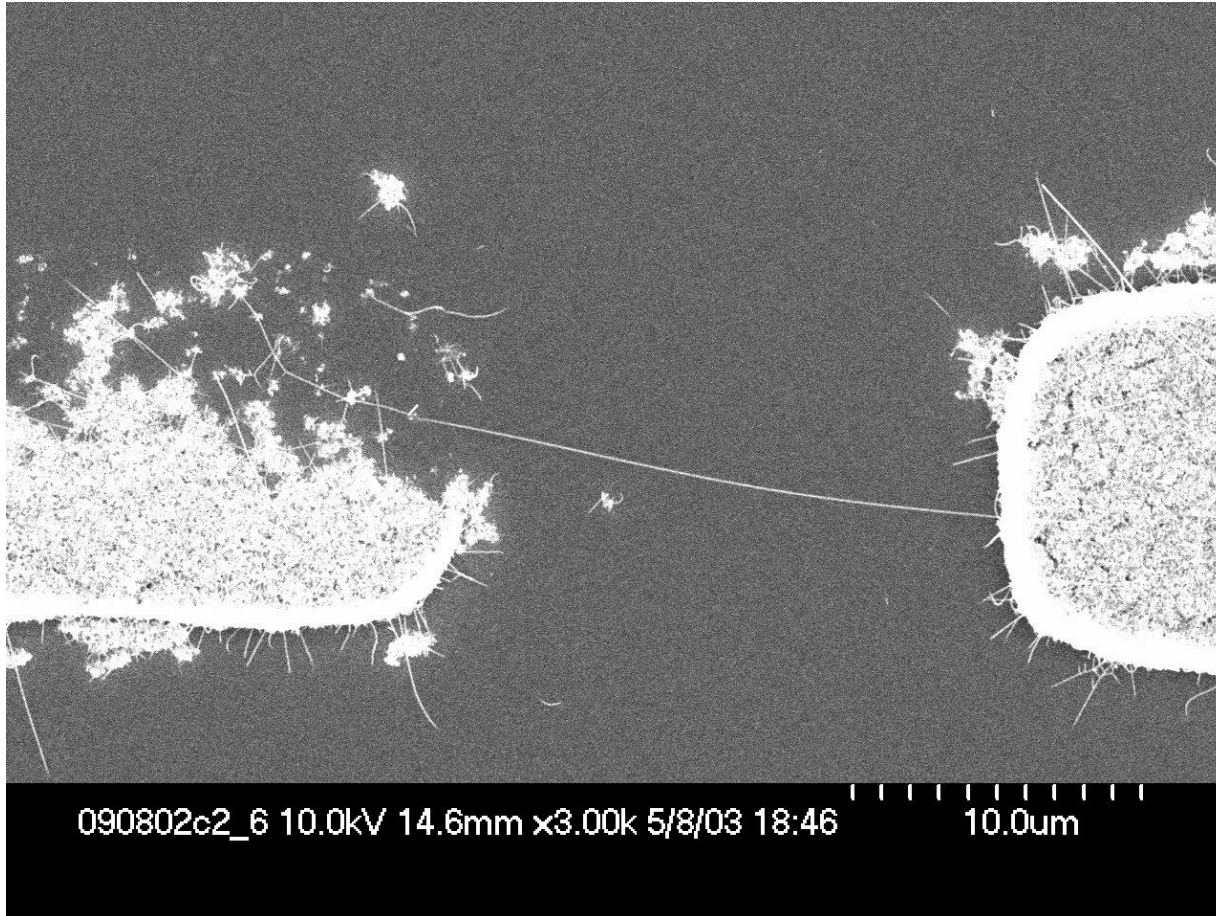

Shengdong Li, unpublished

Single Walled Carbon Nanotube

$L = 0.4 \text{ cm}$

$d/L = \text{cm/nm} = 10^7$

$d = 1.5 \text{ nm}$

Would Schelkunoff be excited?

SWNT

Au

Au

Conductivity larger than copper!

1 mm

S. D. Li, Z. Yu, C. Rutherglen and P. J. Burke, "Electrical Properties of 0.4 Cm Long Single-Walled Carbon Nanotubes", *Nano Letters*, **4**, 2003-2007, (2004).

Ballistic vs. diffusive transport

Diffusive

$$R = \frac{L}{W^2} \rho$$

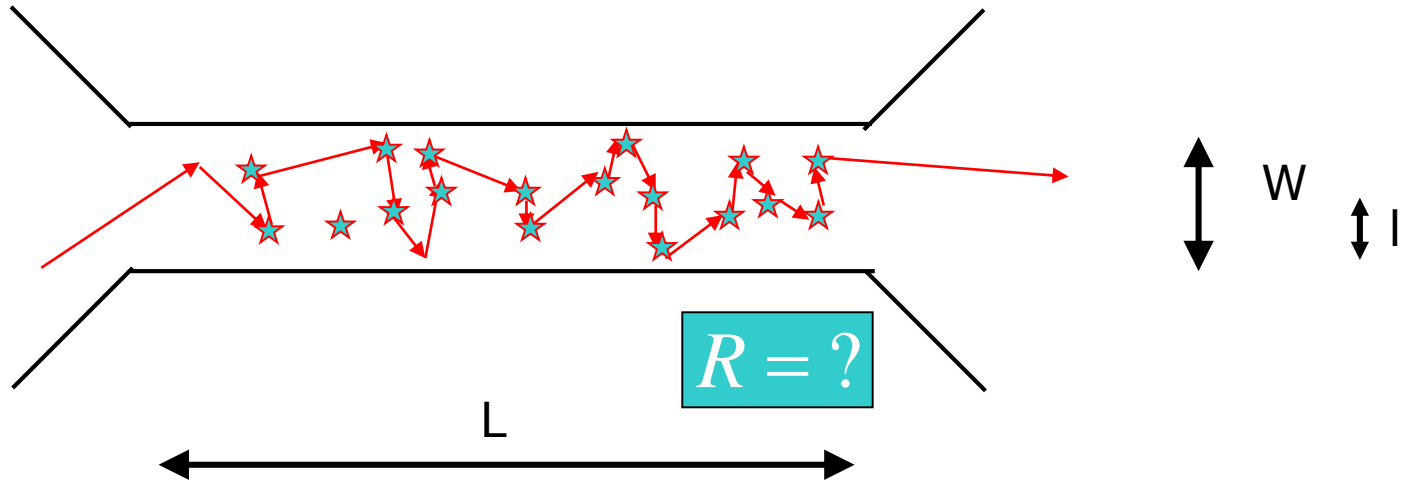

Ballistic

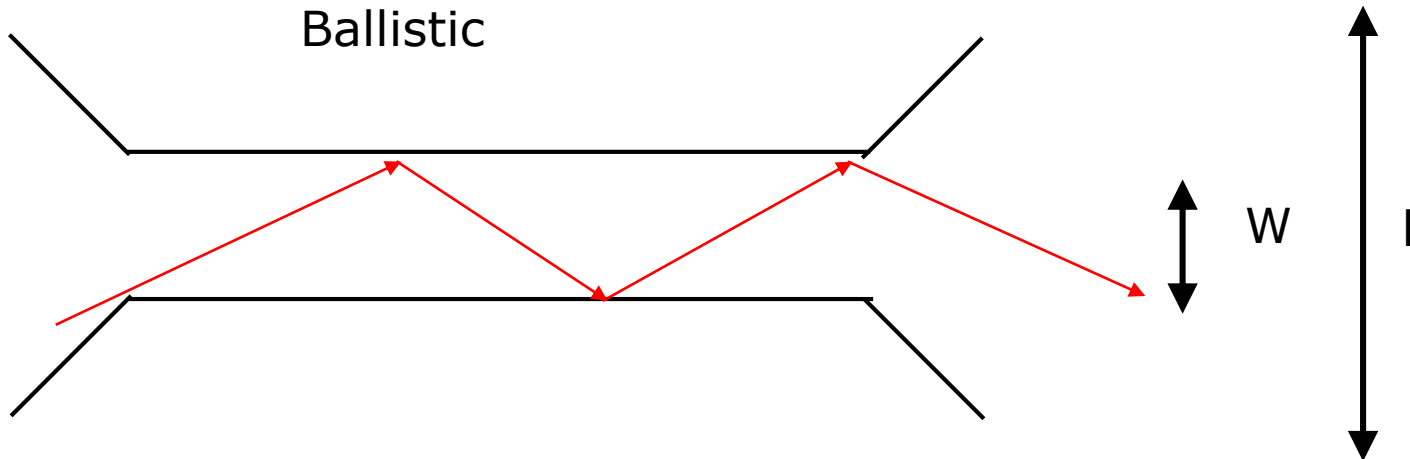

Ballistic vs. diffusive transport

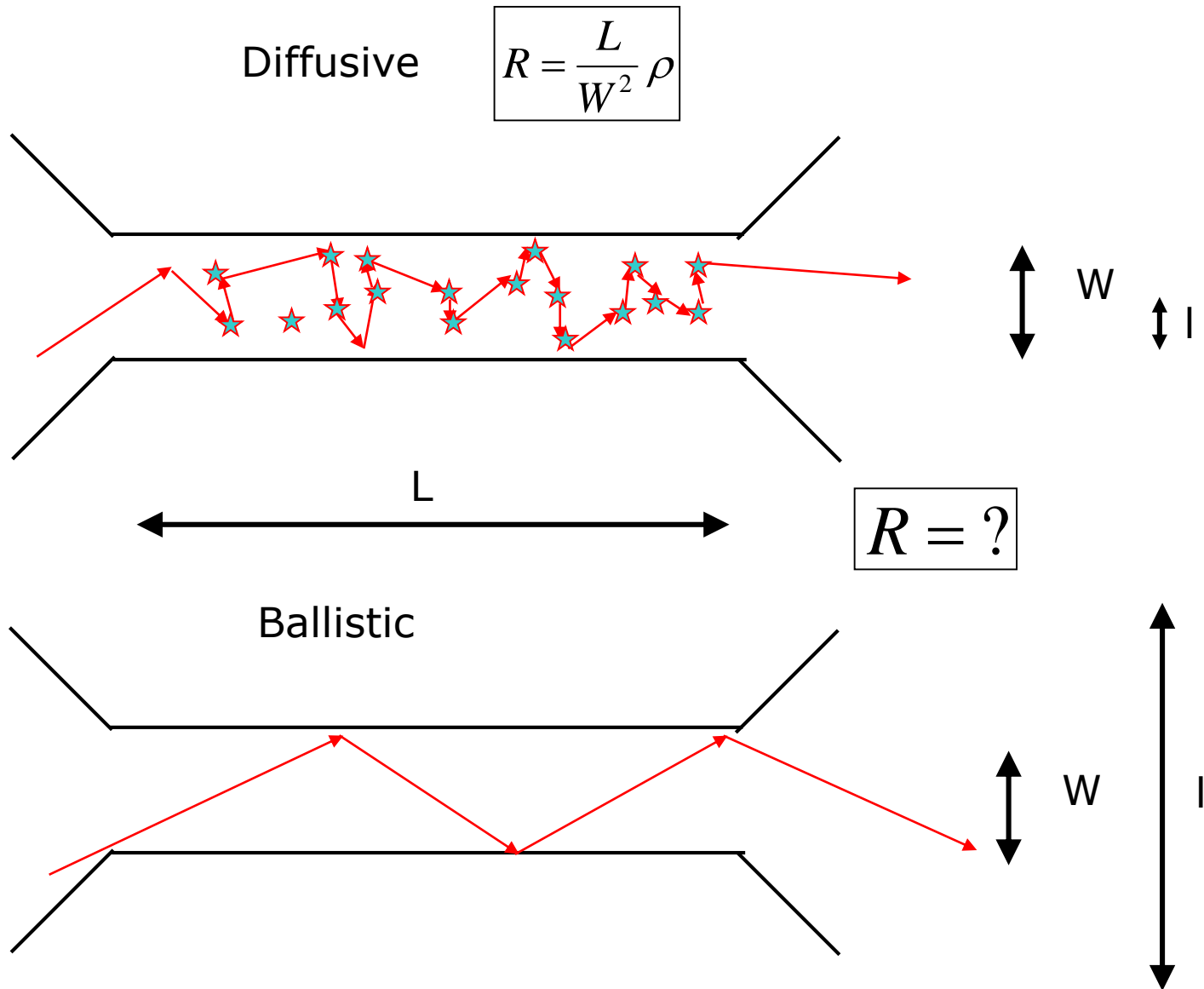

Landauer formula:

$$G = n \frac{2e^2}{h}$$

If the leads are not perfect injectors into each “channel” then:

$$G = \frac{2e^2}{h} \sum T_n$$

Resistance vs. length

$$R(L) = R_{\text{contact}} + \frac{L}{L_{\text{mfp}}} \frac{h}{4e^2}$$

$$R_{\text{contact}} \geq h/4e^2 = 6 \text{ k}\Omega$$

Shengdong Li, Zhen Yu, C. Rutherglen, P. J. Burke "Electrical Properties of 0.4 cm Long Single-Walled Carbon Nanotubes", *Nano Letters*, 2004.

Resistance vs. length

$$R = R_{\text{contact}} + L \cdot 6 \text{ k}\Omega/\mu\text{m}$$

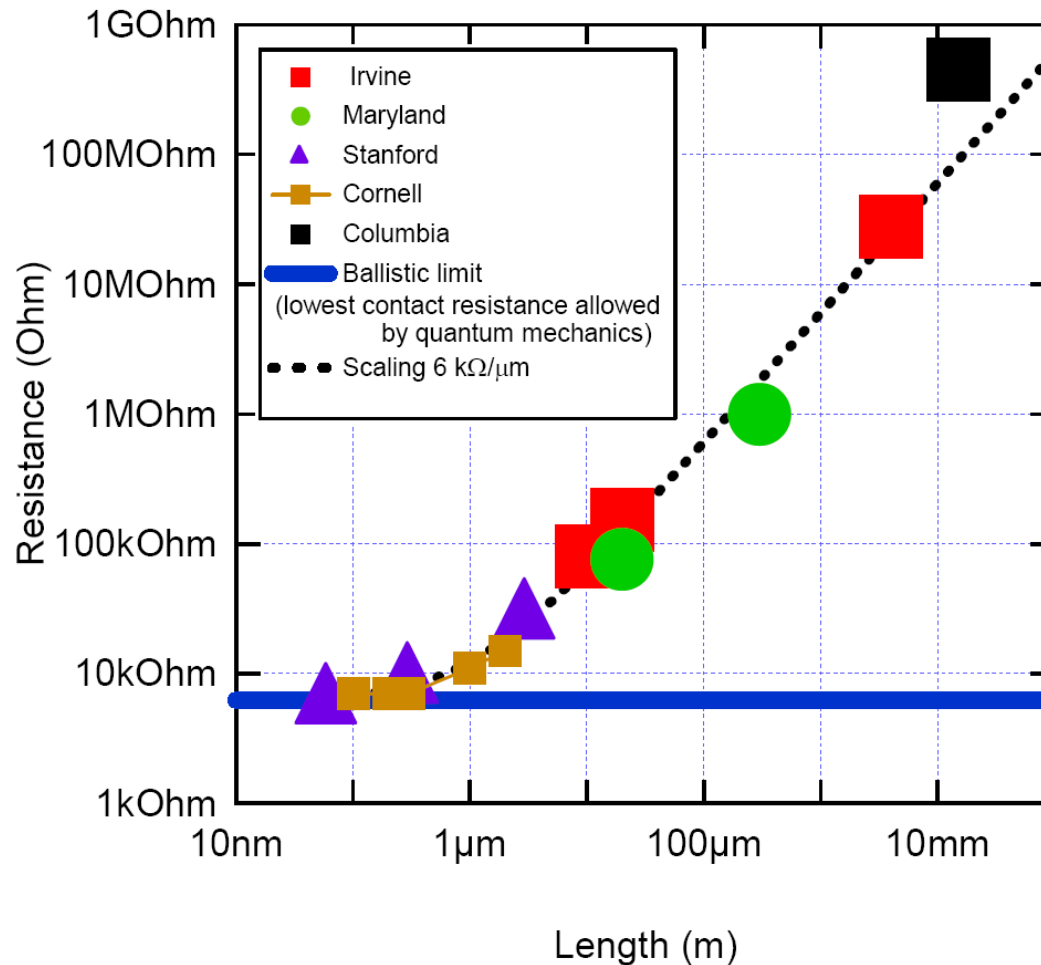

Shengdong Li, Zhen Yu, C. Rutherglen, P. J. Burke "Electrical Properties of 0.4 cm Long Single-Walled Carbon Nanotubes", *Nano Letters*, 2004.

R vs L single tube

PRL 98, 186808 (2007)

PHYSICAL REVIEW LETTERS

week ending
4 MAY 2007



Scaling of Resistance and Electron Mean Free Path of Single-Walled Carbon Nanotubes

Meninder S. Purewal,¹ Byung Hee Hong,² Anirudhh Ravi,² Bhupesh Chandra,³ James Hone,³ and Philip Kim²

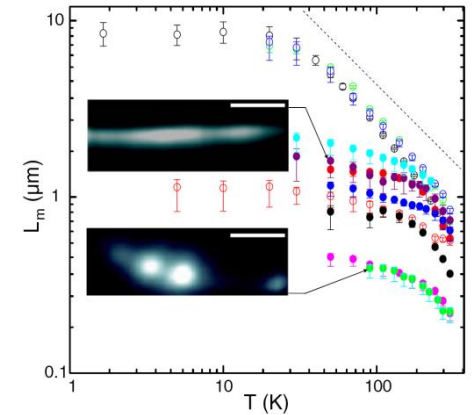
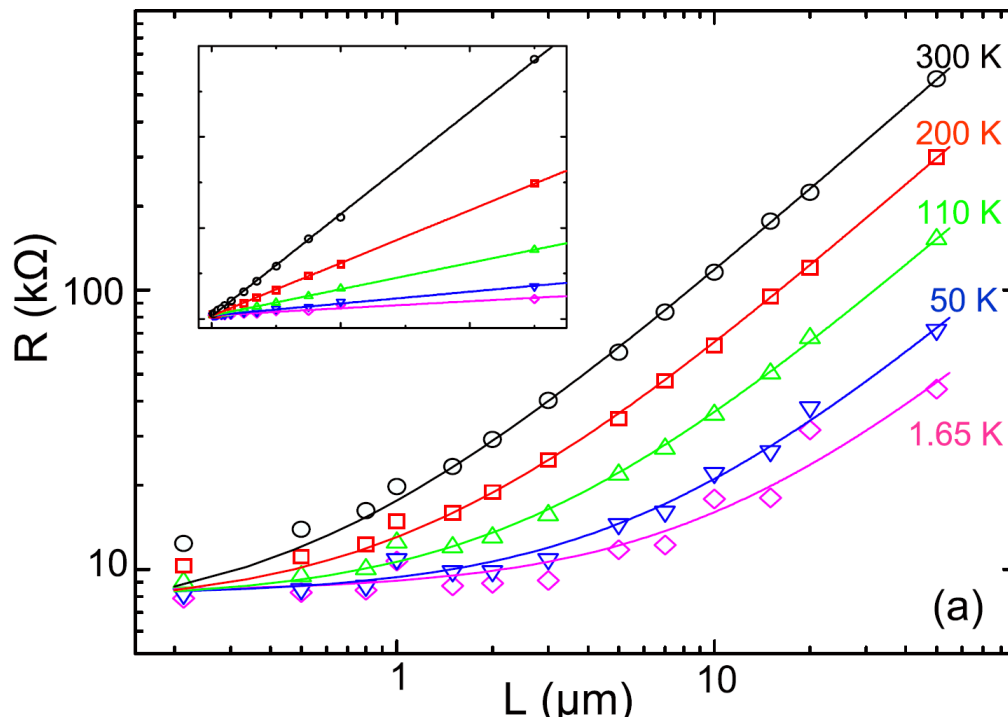
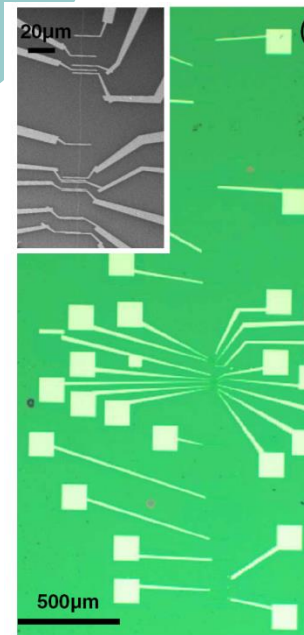

Comparison to Cu

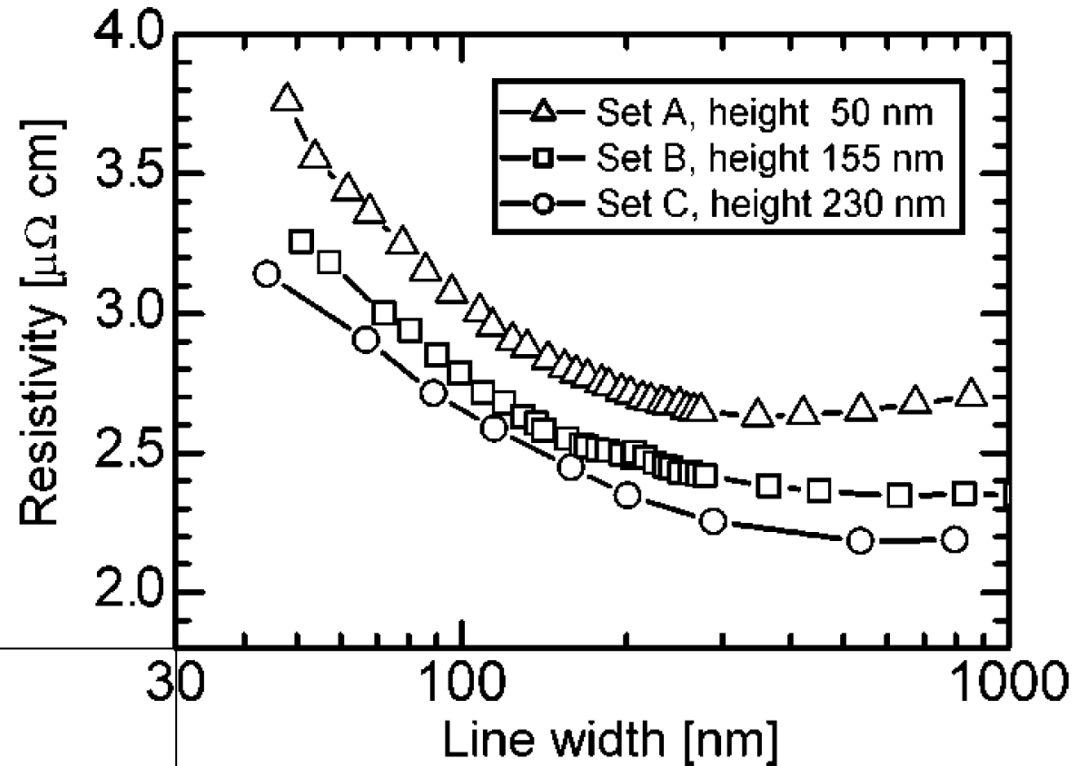

SWNT



$d=1.5\text{ nm}$, $6\text{ k}\Omega/\mu\text{m}$
 $\Rightarrow 1.1\ \mu\Omega\text{-cm}$

[1.] W. Steinhogel, G. Schindler, G. Steinlesberger, M. Traving and M. Engelhardt, "Comprehensive Study of the Resistivity of Copper Wires with Lateral Dimensions of 100 Nm and Smaller", *Journal of Applied Physics*, **97**, 023706, (2005).

High field transport. Diffusive regime

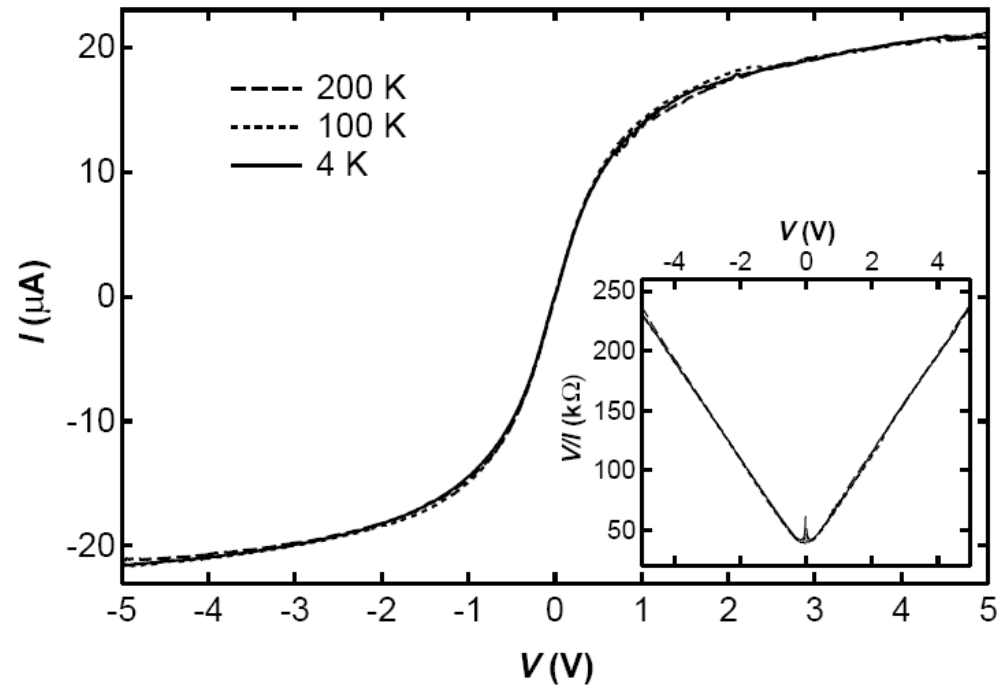
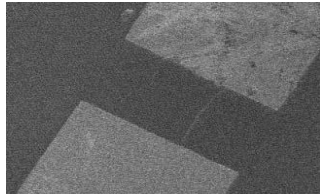

Prior dc work:

High-Field Electrical Transport in Single-Wall Carbon Nanotubes

[Zhen Yao](#)¹, [Charles L. Kane](#)², and [Cees Dekker](#)¹

Phys. Rev. Lett. **84**, 2941 - 2944 (2000)

[Issue 13 - March 2000]

$$V/I = R_0 + |V|/I_0$$



Ohmic p-type contact

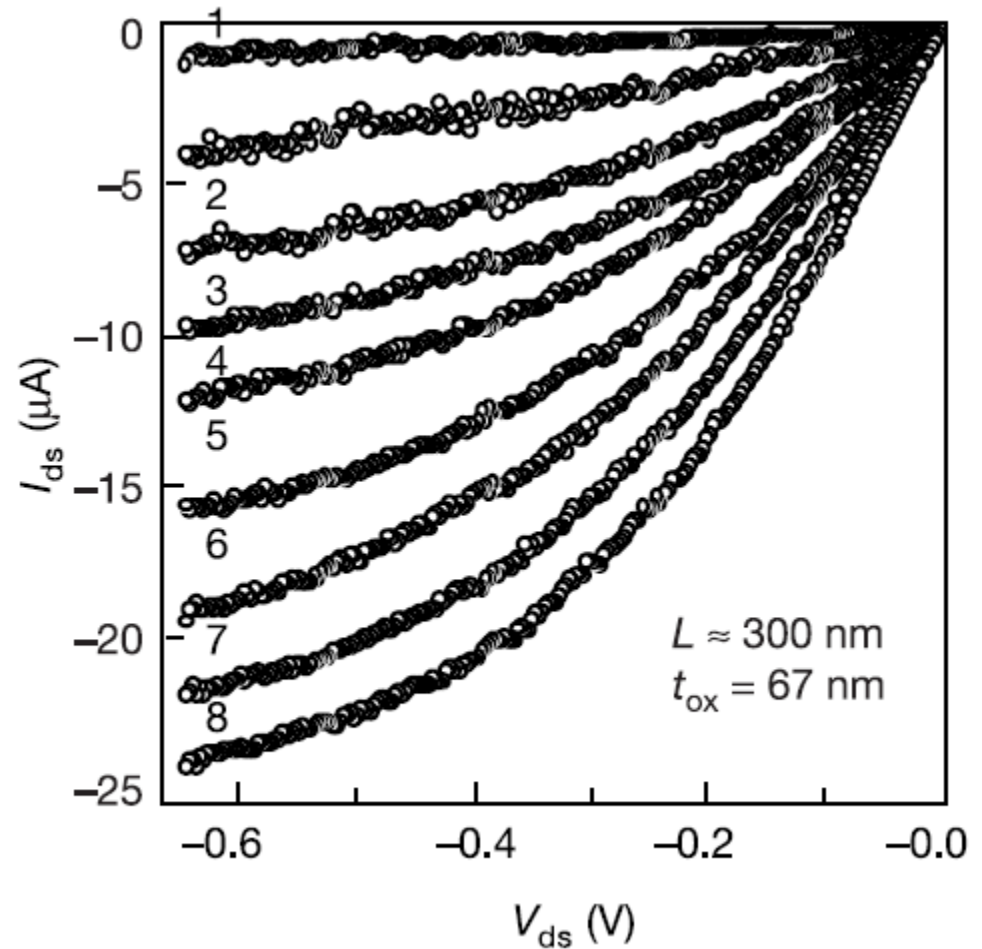
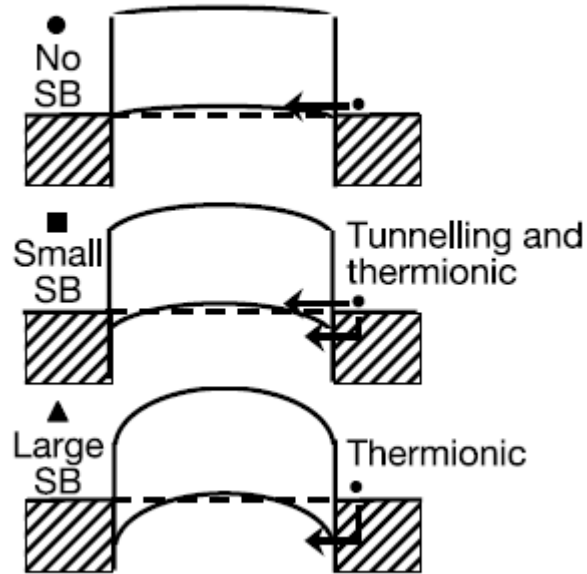

Ballistic carbon nanotube field-effect transistors

Ali Javey Jing Guo Qian Wang Mark Lundstrom & Hongjie Dai

Nature 424, 654 - 657 (2003).

Ohmic n-type contact

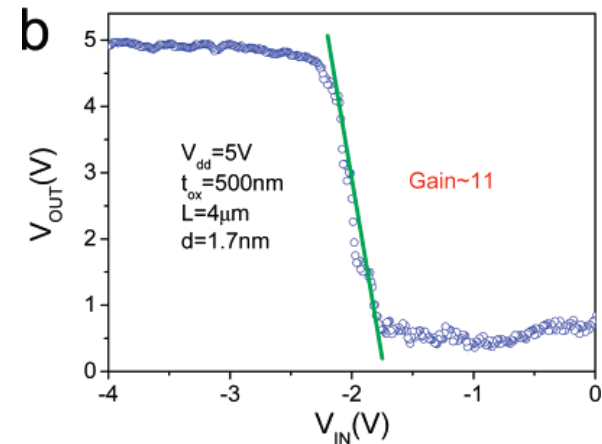
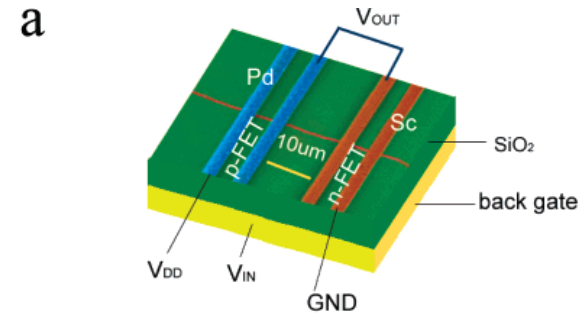
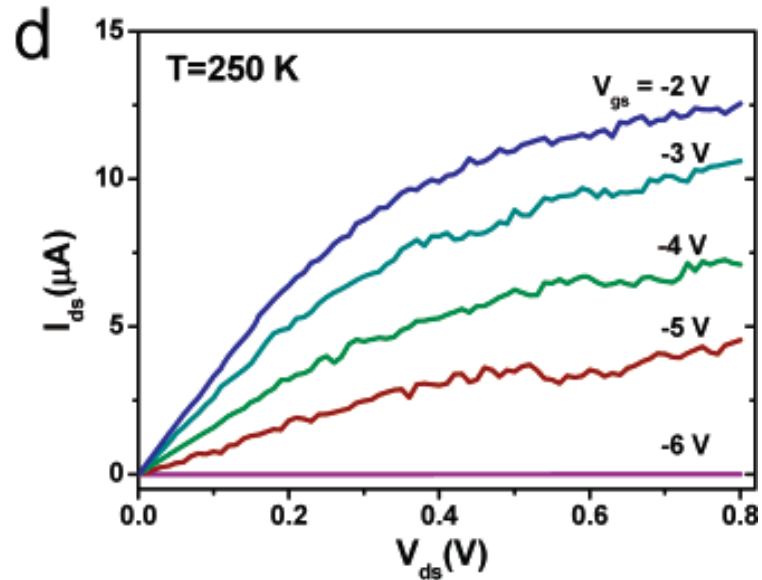
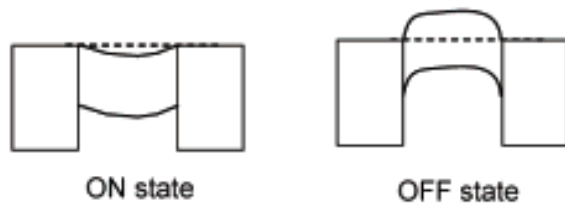

Doping-Free Fabrication of Carbon Nanotube Based Ballistic CMOS Devices and Circuits

Zhang, Z.; Liang, X.; Wang, S.; Yao, K.; Hu, Y.; Zhu, Y.; Chen, Q.; Zhou, W.; Li, Y.; Yao, Y.; Zhang, J.; Peng, L.-
 Nano Lett.; (Letter); 2007; 7(12); 3603-3607

Electrical contact: Role of metals

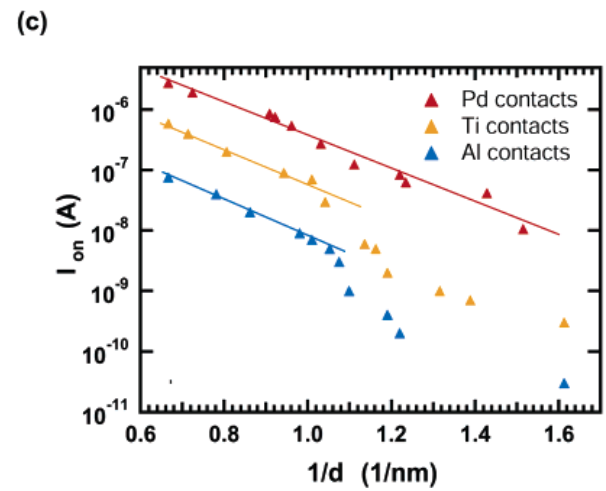
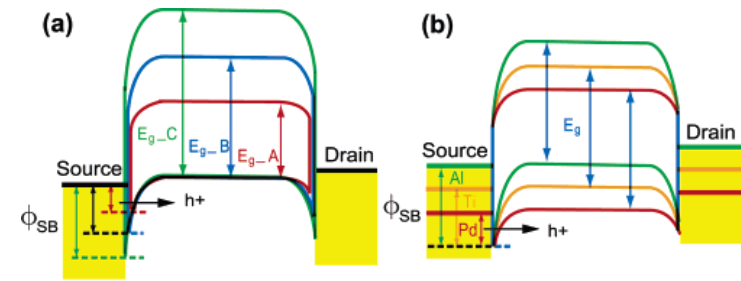
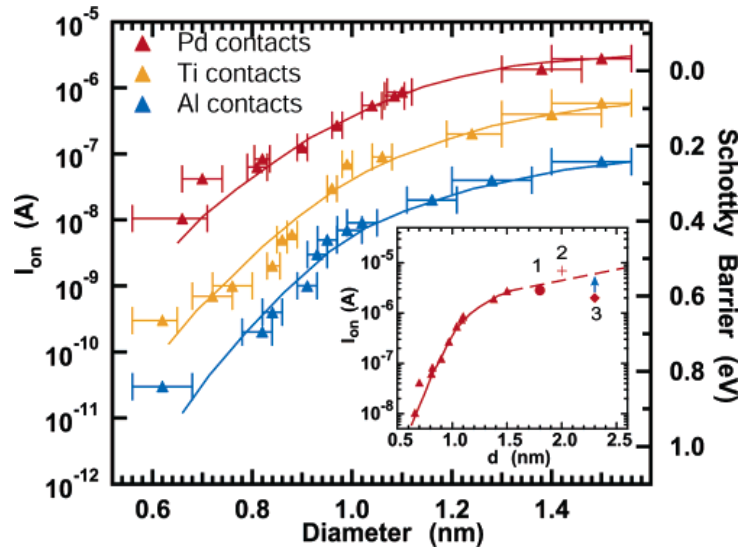

The Role of Metal-Nanotube Contact in the Performance of Carbon Nanotube Field-Effect Transistors
 Chen, Z.; Appenzeller, J.; Knoch, J.; Lin, Y.-M.; Avouris, Ph.
 Nano Lett.; (Letter); 2005; 5(7); 1497-1502.

N-type, p-type, SB FET

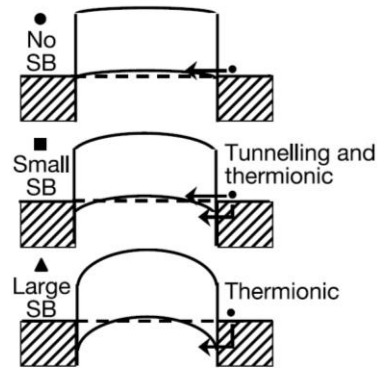
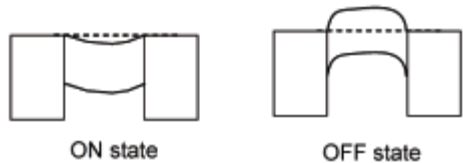

X. Peng, N. Komatsu, S. Bhattacharya, T. Shimawaki, S. Aonuma, T. Kimura and A. Osuka, "Optically Active Single-Walled Carbon Nanotubes", *Nature*, **2**, **361-365**, (2007).

A. Javey, J. Guo, Q. Wang, M. Lundstrom and H. J. Dai, "Ballistic Carbon Nanotube Field-Effect Transistors", *Nature*, **424**, **654**, (2002).

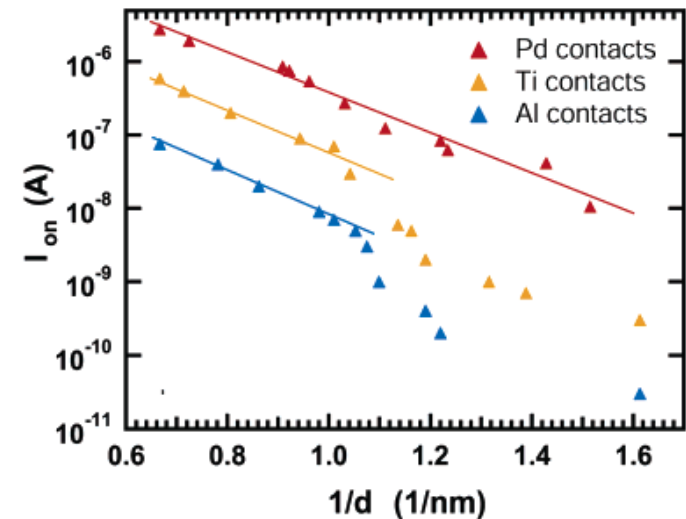
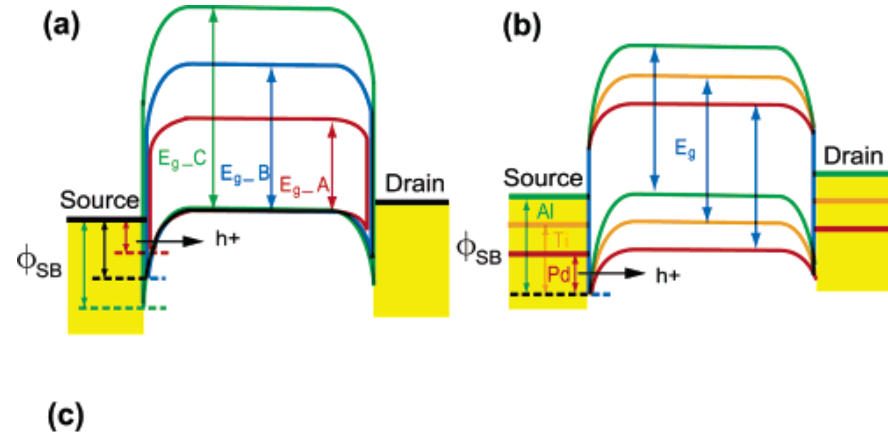
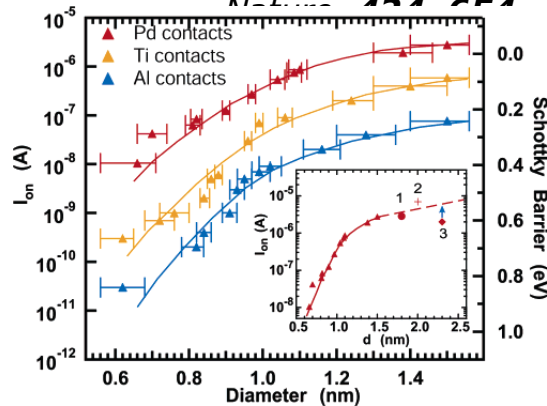

Z. Chen, J. Appenzeller, J. Knoch, Y.-M. Lin and P. Avouris, "The Role of Metal-Nanotube Contact in the Performance of Carbon Nanotube Field-Effect Transistors", *Nano Lett.*, **5**, **1497-1502**, (2005).

Effect of parasitics

$C_{gs} \sim 1-10 \text{ aF}$
 $g_m \sim 10 \mu\text{S}$
 $C_p \sim 100 \text{ aF}$

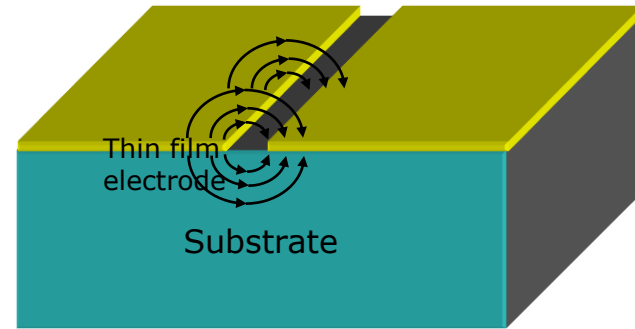
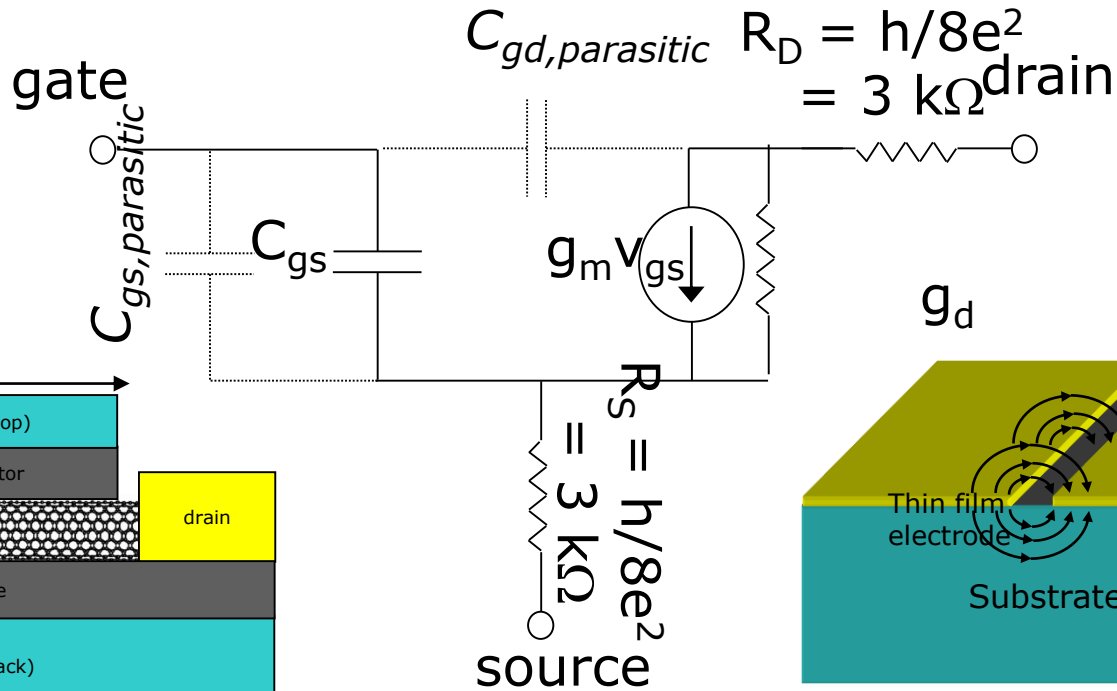
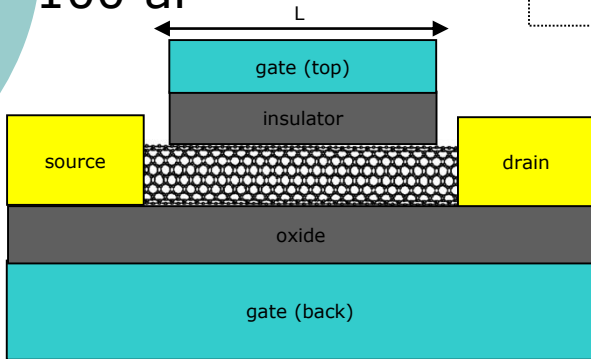

If parasitics minimized:

$$\frac{1}{2\pi f_T} = (R_S + R_D)C_{gd,p} + \frac{1}{g_m}(C_{gs} + C_{gd,p} + C_{gd,p}) + \frac{g_d}{g_m}(R_S + R_D)(C_{gs} + C_{gd,p} + C_{gd,p})$$

$\sim 10 \text{ GHz}$

$$\frac{1}{2\pi f_T} = \frac{C_{gs}}{g_m}$$

$\sim 1 \text{ THz}$

P. J. Burke, "AC Performance of Nanoelectronics: Towards a Ballistic THz Nanotube Transistor", *Solid State Electronics*,



Nanotube density

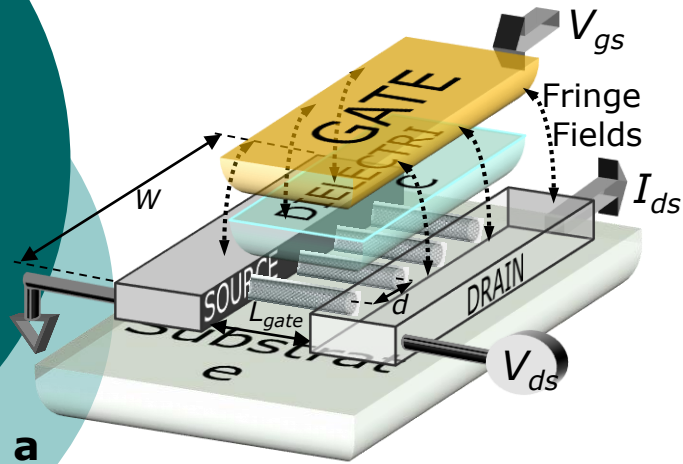

$$f_T = \frac{g_m}{2\pi C_{gs}}$$

$$f_T = \frac{g_m}{2\pi C_{gs}} \left(\frac{1}{1 + \frac{C_w}{C_{gs}} d} \right)$$

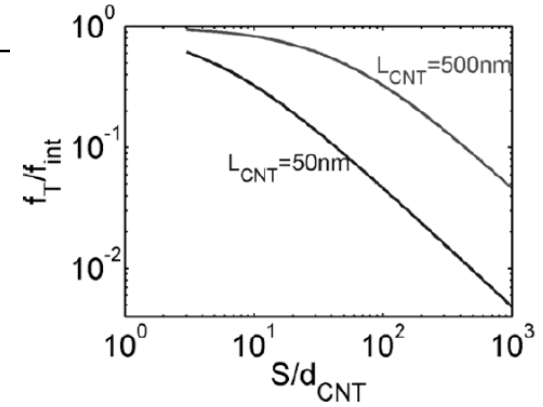

J. Guo, S. Hasan, A. Javey, G. Bosman and M. Lundstrom, "Assessment of High-Frequency Performance Potential of Carbon Nanotube Transistors", *IEEE Transactions on Nanotechnology*, **4**, 715-721, (2005).

C. Rutherglen, D. Jain and P. Burke, "Nanotube Electronics for RF Applications", *Nature Nanotechnology*, in press, (2009).

$$v_{drift} = \begin{cases} \mu E & E = V_{ds}/L_{gate} \text{ small} \Leftrightarrow L_{gate} \text{ large} \\ v_{sat} & E = V_{ds}/L_{gate} \text{ large} \Leftrightarrow L_{gate} \text{ small} \end{cases}$$

$$f_T = \begin{cases} \mu(V_{gate} - V_T)/\pi L_{gate}^2 & L_{gate} \text{ "large"} \\ v_{sat}/2\pi L_{gate} & L_{gate} \text{ "small"} \end{cases}$$

$$f_{max} \approx \frac{f_T}{2[g_d(R_{parasitic,s} + R_{gate}) + 2\pi f_T C_{parasitic,gd} R_{gate}]^{1/2}}$$

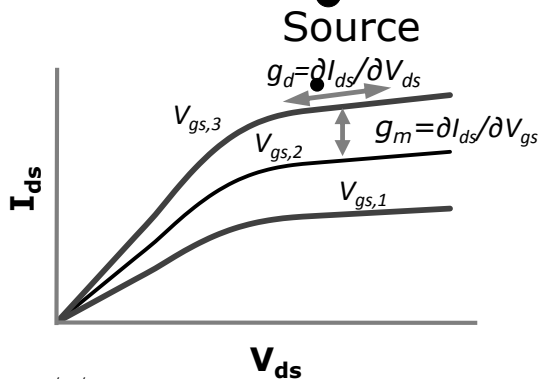
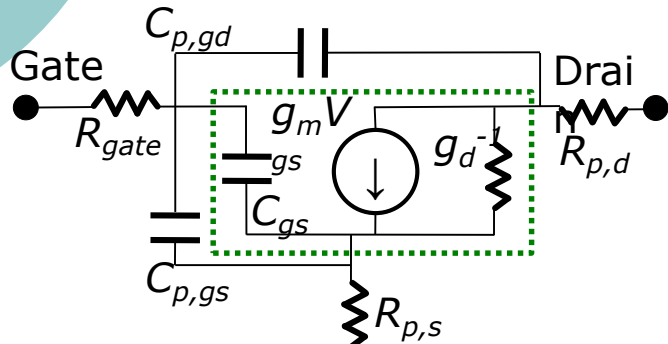

Dense arrays on quartz

- What is length, diameter, chirality, impurity density of each tube on wafer scale?
- Raman?
- PL?
- Other techniques?

L. Ding, D. Yuan and J. Liu, "Growth of High-Density Parallel Arrays of Long Single-Walled Carbon Nanotubes on Quartz Substrates", *J. Am. Chem. Soc.*, **130**, 5428-5429, (2008).

C. Kocabas, S. H. Hur, A. Gaur, M. A. Meitl, M. Shim and J. A. Rogers, "Guided Growth of Large-Scale, Horizontally Aligned Arrays of Single-Walled Carbon Nanotubes and Their Use in Thin-Film Transistors", *Small*, **1**, 1110-1116, (2005).

S. Han, X. Liu and C. Zhou, "Template-Free Directional Growth of Single-Walled Carbon Nanotubes on a- and R-Plane Sapphire", *J. Am. Chem. Soc.*, **127**, 5294-5295, (2005).

Z. Chongwu, L. Xiaolei, H. Song and I. Fumiaki, "A Nanotube-on-Insulator (Noi) Approach toward Scalable and Integratable Nanotube Devices on Sapphire", in *Solid-State and Integrated Circuit Technology, 2006. ICSICT '06. 8th International Conference on. 2006. p. 1065-1067.*

W. Zhou, C. Rutherglen and P. Burke, "Wafer Scale Synthesis of Dense Aligned Arrays of Swnts", *Nano Research*, **1**, 158-165, (2008).

H. Ago, K. Imamoto, N. Ishigami, R. Ohdo, K. Ikeda and M. Tsuji, "Competition and Cooperation between Lattice-Oriented Growth and Step-Templated Growth of Aligned Carbon Nanotubes on Sapphire", *Applied Physics Letters*,

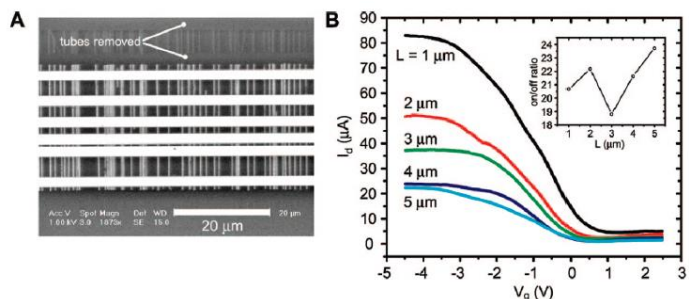

Alignment: Status & Goals

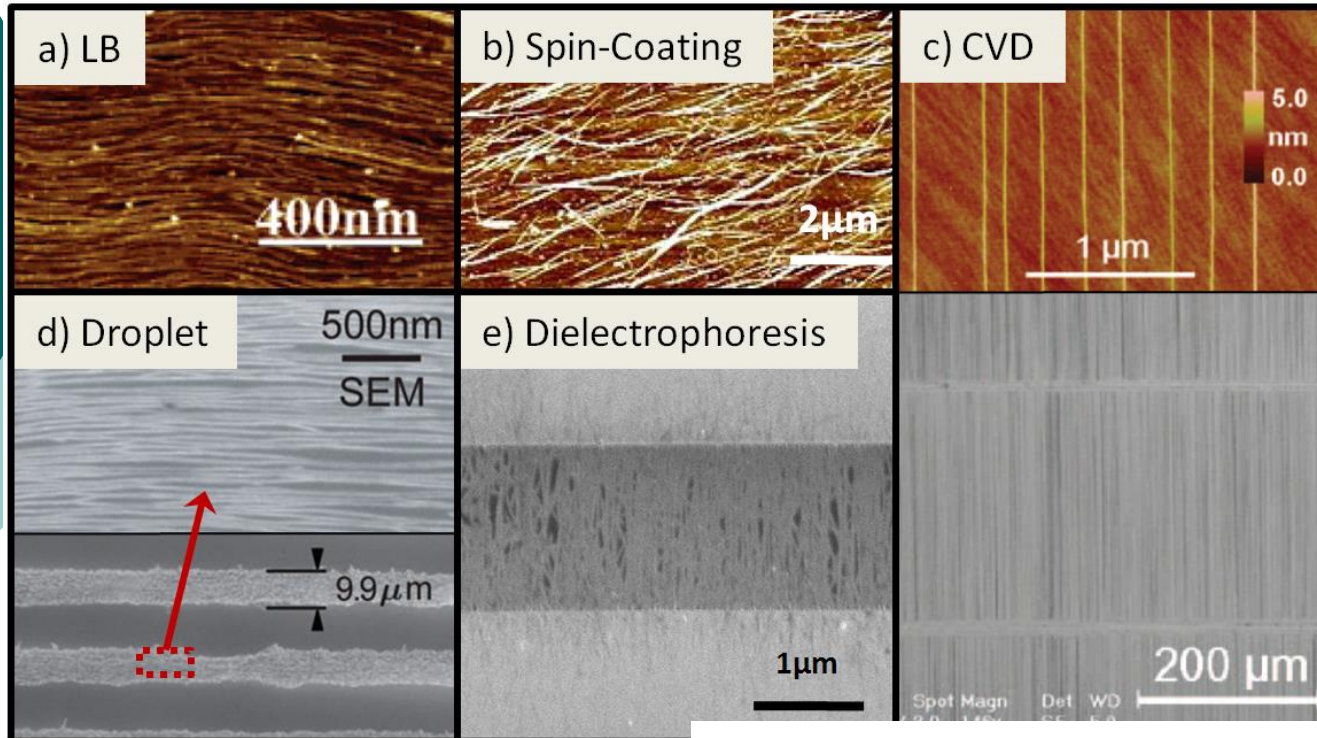

C. Rutherglen, D. Jain and P. Burke,
 "Nanotube Electronics for RF Applications",
Nature Nanotechnology, in press, (**2009**).

Property/Parameter	Target Value or Range	Justification
Diameter	1.5 – 2.0 nm	•Current is largest in this range ^{107,108} .
Chirality	semiconducting & same (n,m)	•To obtain identical transport properties.
Purity	>99%	• No metallics for high gain and f_{Max}
Length	> 1 µm	•SWNT length must be longer than the intended electrode gap channel length.
Density	>10 SWNT/µm	• Reduces parasitic capacitance, increases current carrying capacity, and improves impedance matching.
Alignment	All parallel	•Result in higher transconductance, and denser SWNT packing
Uniformity	Wafer scale	•Essential for large scale processing.

Mobilities

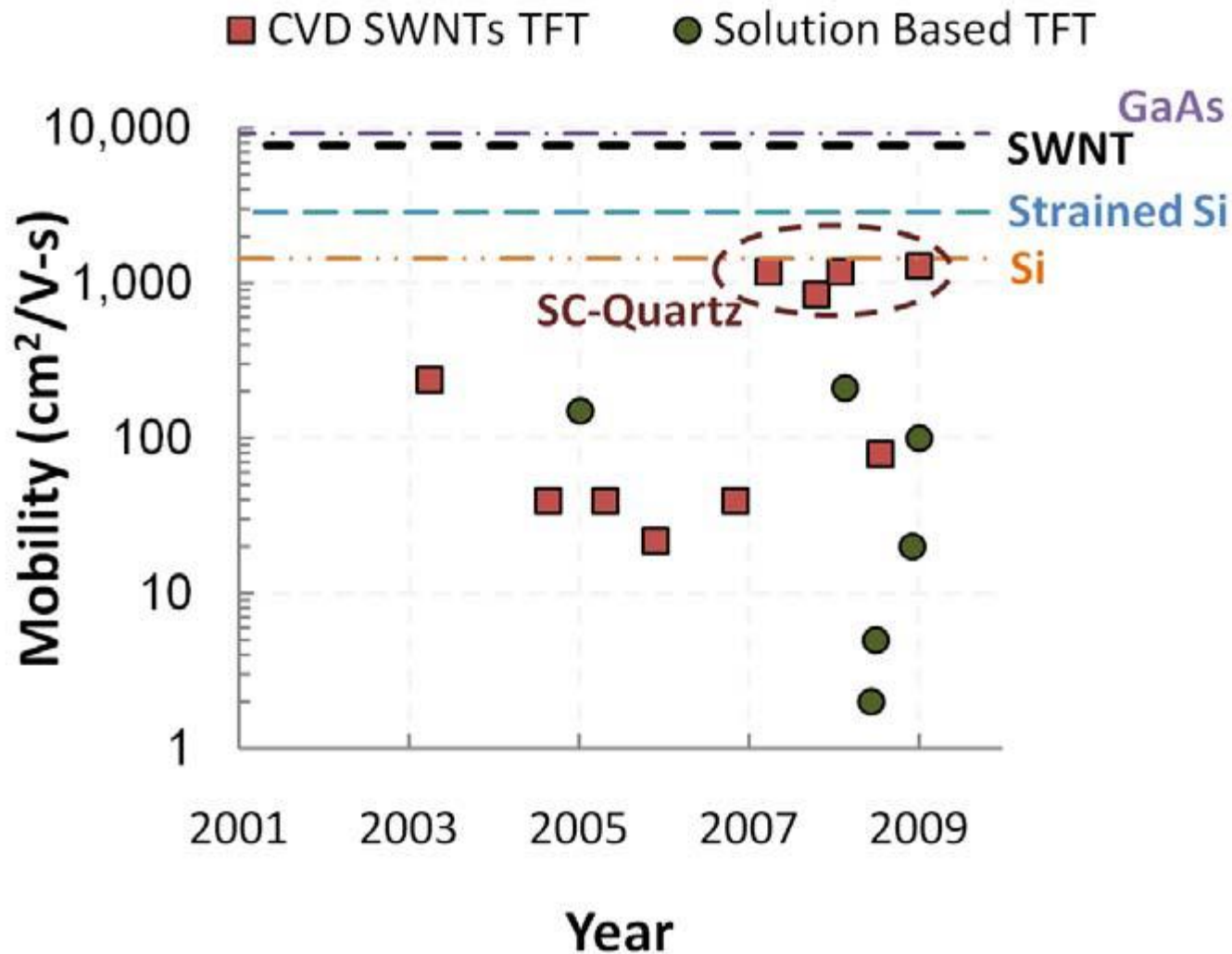

C. Rutherglen, D. Jain and P. Burke, "Nanotube Electronics for Radiofrequency Applications", *Nature Nanotechnology*, **4**, 811-819, (2009).



(n,m) enrichment

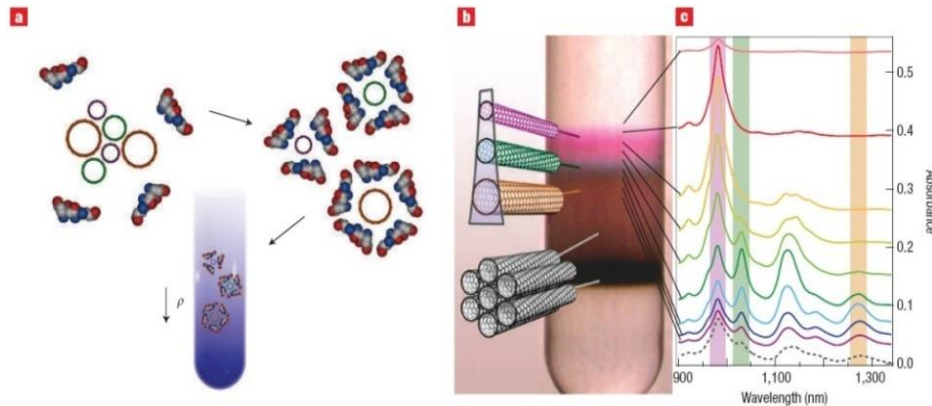

- CNTs are surfactant encapsulated and separate by density during centrifugation

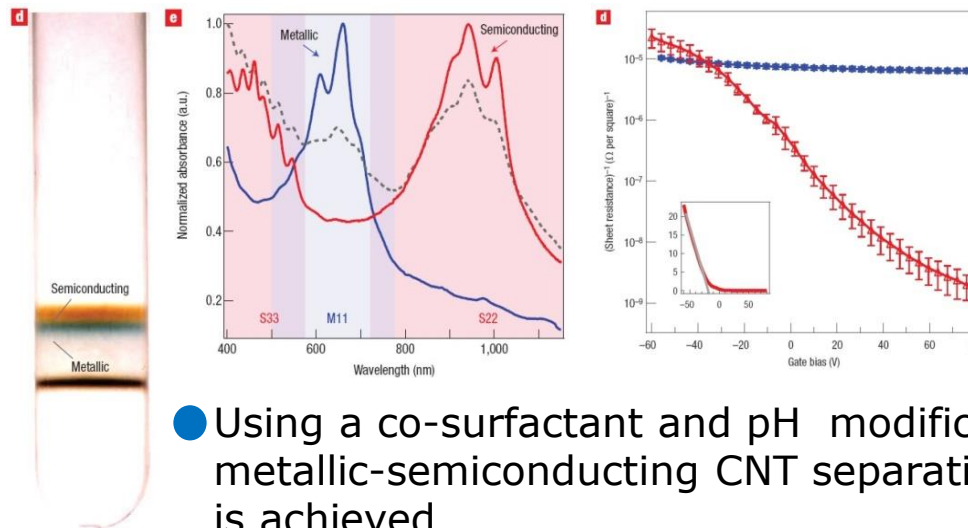

- Using a co-surfactant and pH modification, metallic-semiconducting CNT separation is achieved

M. Hersam, "Progress Towards Monodisperse Single-Walled Carbon Nanotubes", *Nature Nanotechnology*, **3**, 387-394, **(2008)**.



Comparison to other semiconductors

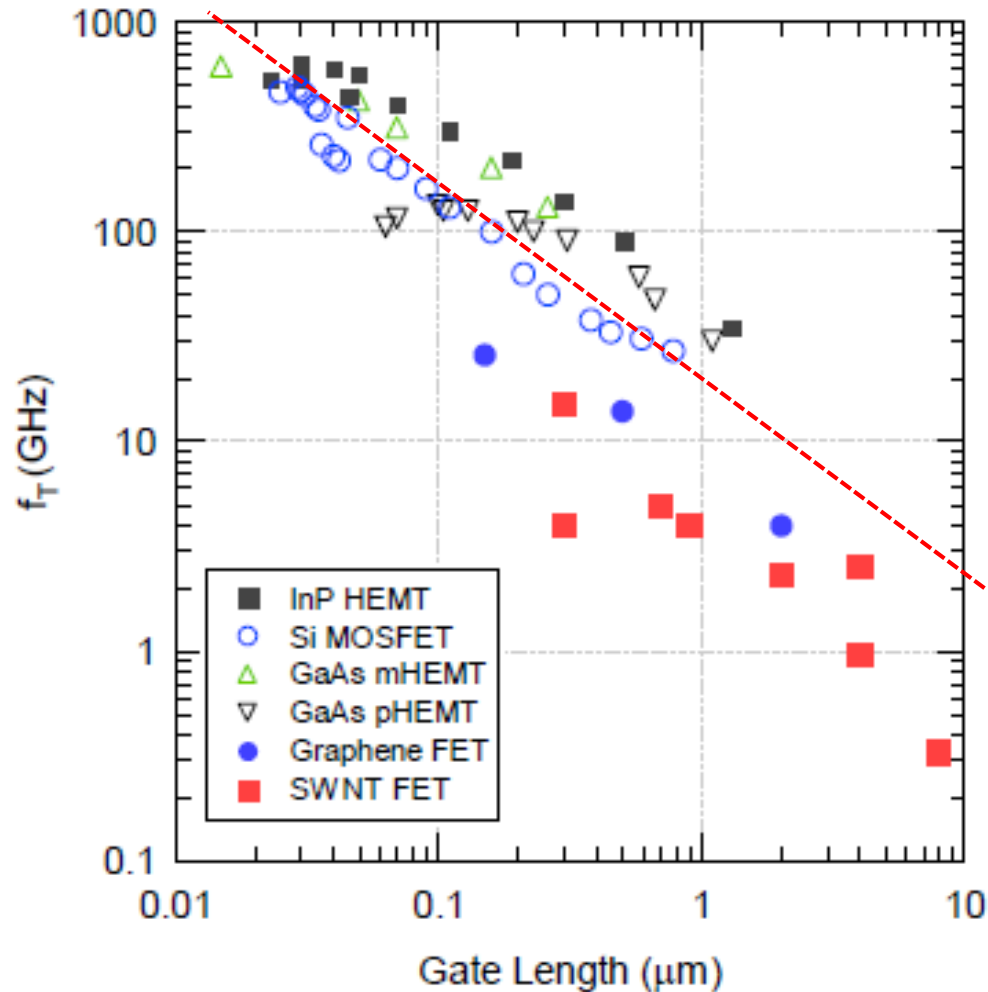

Dashed line:
 1.2×10^7 cm/s v_{Sat}
(Rogers)

Graphene (Kim)
0.5 to 5x that value

C. Rutherglen, D. Jain and P. Burke, "Nanotube Electronics for RF Applications", *Nature Nanotechnology*, in press, (**2009**).